



Svetovanje in i inženiring na področju elektronskega poslovanja

www.panteongroup.org
www.panteon.biz

DOKUMENATACIJA

Panteon.biz® DESADV XML 1.00

REFERENCA	: DESADV_XML_HR
VERZIJA	: 1.0.04
DATUM	: 09. 05. 2006
AVTOR	: PETER

1. Saržaj

1. Saržaj.....	2
2. Shema XML dokumenata (Dostavnica).....	3
3. Opis elemenata.....	4
4. Opis i značenje polja.....	14

2. Shema XML dokumenata (Dostavnica)

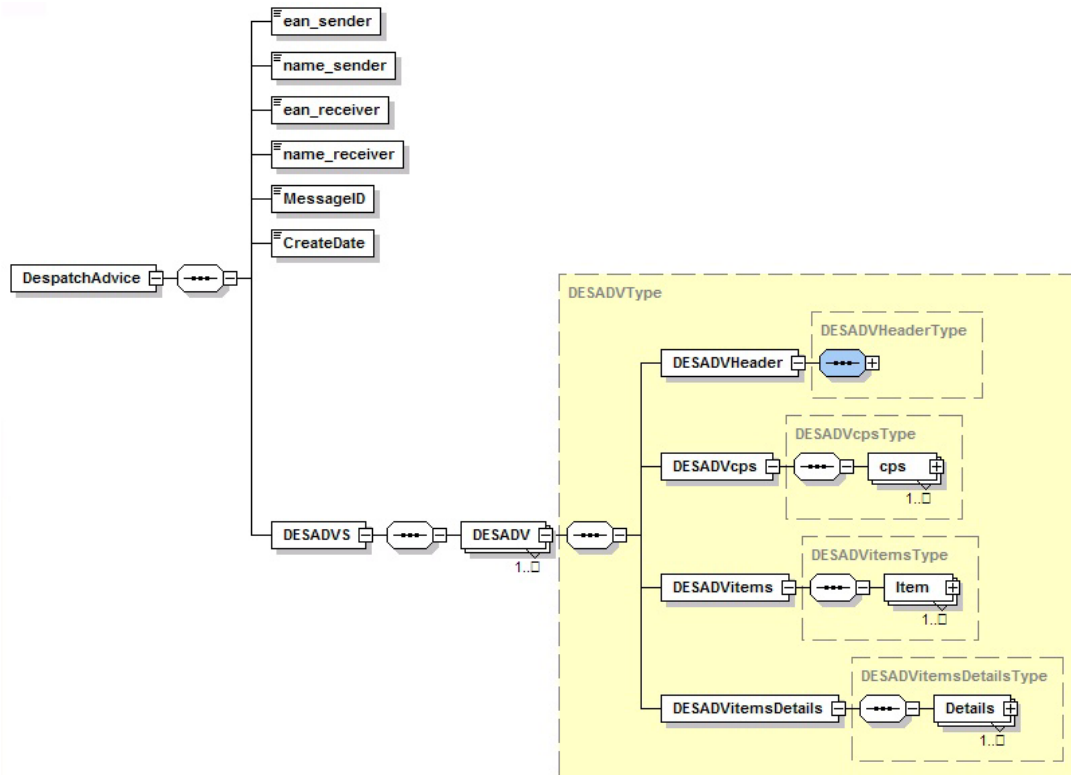

3. Opis elemenata

element DespatchAdvice

diagram

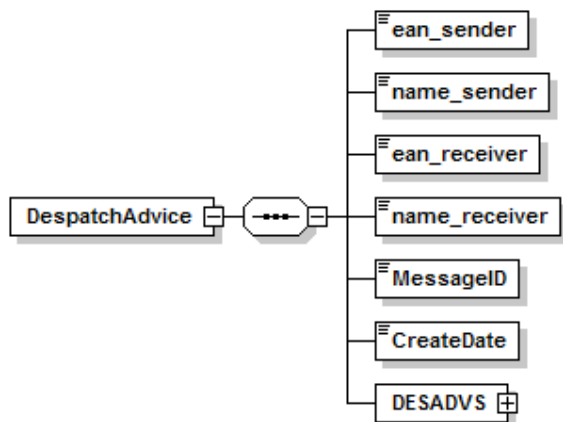

namespace <https://3s.panteon.biz/schemes/desadv>

properties content complex

children [ean_sender](#) [name_sender](#) [ean_receiver](#) [name_receiver](#) [MessageID](#) [CreateDate](#) [DESADVS](#)

```
<xs:element name="DespatchAdvice">
  <xs:complexType>
    <xs:sequence>
      <xs:element name="ean_sender" type="xs:integer"/>
      <xs:element name="name_sender" type="xs:string"/>
      <xs:element name="ean_receiver" type="xs:integer"/>
      <xs:element name="name_receiver" type="xs:string"/>
      <xs:element name="MessageID" type="xs:integer"/>
      <xs:element name="CreateDate" type="xs:string"/>
      <xs:element name="DESADVS">
        <xs:complexType>
          <xs:sequence>
            <xs:element name="DESADV" type="DESADVType" maxOccurs="unbounded"/>
          </xs:sequence>
        </xs:complexType>
      </xs:element>
    </xs:sequence>
  </xs:complexType>
</xs:element>
```

element **DespatchAdvice/ean_sender**

(GLN Pošiljatelja XML dokumenata) vrijednost JE obavezna

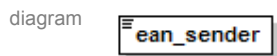

namespace <https://3s.panteon.biz/schemes/desadv>

type **xs:integer**

properties isRef 0
content simple

source `<xs:element name="ean_sender" type="xs:integer"/>`

element **DespatchAdvice/name_sender**

(Naziv Pošiljatelja XML dokumenata) vrijednost JE obavezna

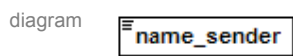

namespace <https://3s.panteon.biz/schemes/desadv>

type **xs:string**

properties isRef 0
content simple

source `<xs:element name="name_sender" type="xs:string"/>`

element **DespatchAdvice/ean_receiver**

(GLN Prijemnika XML dokumenata) vrijednost JE obavezna

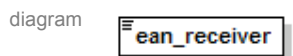

namespace <https://3s.panteon.biz/schemes/desadv>

type **xs:integer**

properties isRef 0
content simple

source `<xs:element name="ean_receiver" type="xs:integer"/>`

element **DespatchAdvice/name_receiver**

(Naziv Prijemnika XML dokumenata) vrijednost JE obavezna

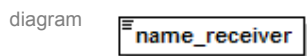

namespace <https://3s.panteon.biz/schemes/desadv>

type **xs:string**

properties isRef 0
content simple

source `<xs:element name="name_receiver" type="xs:string"/>`

element **DespatchAdvice/MessageID**

(Broj XML dokumenata) vrijednost JE obavezna



namespace <https://3s.panteon.biz/schemes/desadv>

type **xs:integer**

properties isRef 0
content simple

source `<xs:element name="MessageID" type="xs:integer"/>`

element **DespatchAdvice/CreateDate**
(Datum kreiranja XML dokumenata) vrijednost JE obavezna

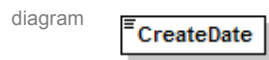

namespace `https://3s.panteon.biz/schemes/desadv`

type **xs:string**

properties isRef 0
 content simple

source `<xs:element name="CreateDate" type="xs:string"/>`

element DespatchAdvice/DESADVS

diagram

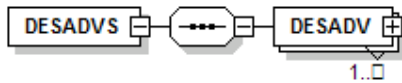

namespace <https://3s.panteon.biz/schemes/desadv>

properties isRef 0
content complex

children [DESADV](#)

source

```
<xs:element name="DESADVS">
  <xs:complexType>
    <xs:sequence>
      <xs:element name="DESADV" type="DESADVType" maxOccurs="unbounded"/>
    </xs:sequence>
  </xs:complexType>
</xs:element>
```

element DespatchAdvice/DESADVS/DESADV

diagram

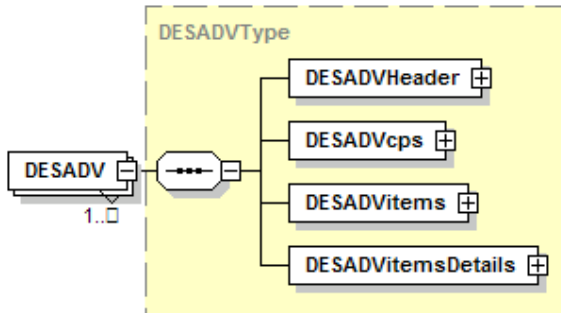

namespace <https://3s.panteon.biz/schemes/desadv>

type [DESADVType](#)

properties isRef 0
minOcc 1
maxOcc unbounded
content complex

children [DESADVHeader](#) [DESADVcps](#) [DESADVitems](#) [DESADVitemsDetails](#)

source

```
<xs:element name="DESADV" type="DESADVType" maxOccurs="unbounded"/>
```

element **DESADVHeader**

diagram

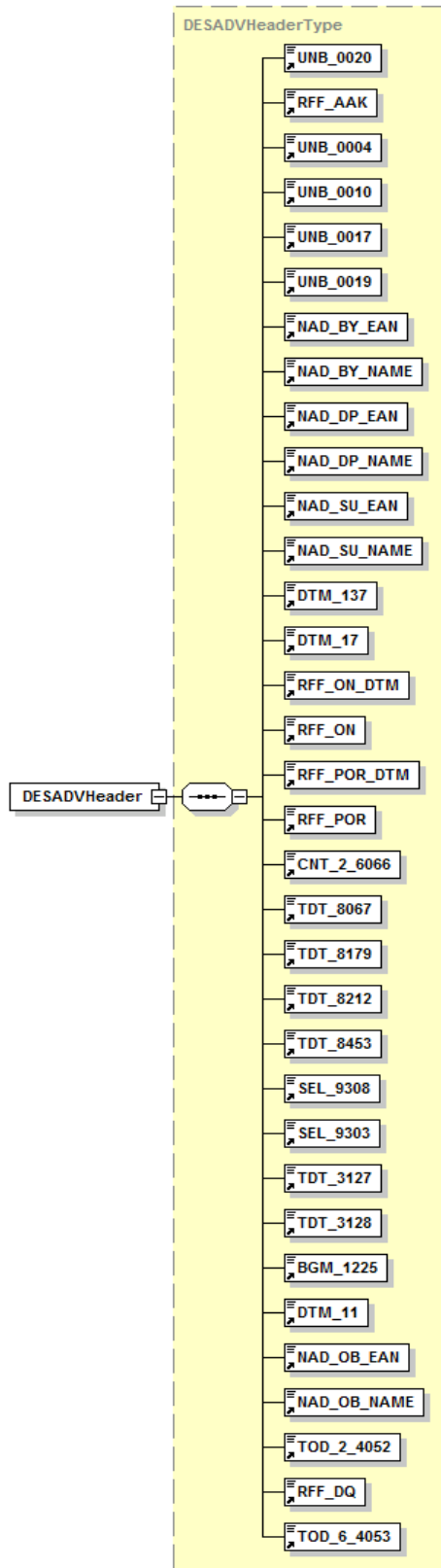

namespace <https://3s.panteon.biz/schemes/desadv>

type [DESADVHeaderType](#)

properties isRef 0
content complex

children [UNB_0020](#) [RFF_AAK](#) [UNB_0004](#) [UNB_0010](#) [UNB_0017](#) [UNB_0019](#) [NAD_BY_EAN](#) [NAD_BY_NAME](#) [NAD_DP_EAN](#) [NAD_DP_NAME](#) [NAD_SU_EAN](#) [NAD_SU_NAME](#) [DTM_137](#) [DTM_17](#) [RFF_ON_DTM](#) [RFF_ON](#) [RFF_POR_DTM](#) [RFF_POR](#) [CNT_2_6066](#) [TDT_8057](#) [TDT_8179](#) [TDT_8212](#) [TDT_8453](#) [SEL_9308](#) [SEL_9303](#) [TDT_3127](#) [TDT_3128](#) [BGM_1225](#) [DTM_11](#) [NAD_OB_EAN](#) [NAD_OB_NAME](#) [TOD_2_4052](#) [RFF_DQ](#) [TOD_6_4053](#)

source

```
<xs:complexType name="DESADVHeaderType">
  <xs:sequence>
    <xs:element ref="UNB_0020"/>
    <xs:element ref="RFF_AAK"/>
    <xs:element ref="UNB_0004"/>
    <xs:element ref="UNB_0010"/>
    <xs:element ref="UNB_0017"/>
    <xs:element ref="UNB_0019"/>
    <xs:element ref="NAD_BY_EAN"/>
    <xs:element ref="NAD_BY_NAME"/>
    <xs:element ref="NAD_DP_EAN"/>
    <xs:element ref="NAD_DP_NAME"/>
    <xs:element ref="NAD_SU_EAN"/>
    <xs:element ref="NAD_SU_NAME"/>
    <xs:element ref="DTM_137"/>
    <xs:element ref="DTM_17"/>
    <xs:element ref="RFF_ON_DTM"/>
    <xs:element ref="RFF_ON"/>
    <xs:element ref="RFF_POR_DTM"/>
    <xs:element ref="RFF_POR"/>
    <xs:element ref="CNT_2_6066"/>
    <xs:element ref="TDT_8057"/>
    <xs:element ref="TDT_8179"/>
    <xs:element ref="TDT_8212"/>
    <xs:element ref="TDT_8453"/>
    <xs:element ref="SEL_9308"/>
    <xs:element ref="SEL_9303"/>
    <xs:element ref="TDT_3127"/>
    <xs:element ref="TDT_3128"/>
    <xs:element ref="BGM_1225"/>
    <xs:element ref="DTM_11"/>
    <xs:element ref="NAD_OB_EAN"/>
    <xs:element ref="NAD_OB_NAME"/>
    <xs:element ref="TOD_2_4052"/>
    <xs:element ref="RFF_DQ"/>
    <xs:element ref="TOD_6_4053"/>
  </xs:sequence>
</xs:complexType>
```

element **DESADVcps**

diagram

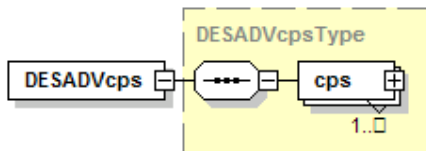

namespace <https://3s.panteon.biz/schemes/desadv>

type [DESADVcpsType](#)

properties isRef 0
content complex

children [cps](#)

source

```
<xs:complexType name="DESADVcpsType">
  <xs:sequence>
    <xs:element name="cps" type="cpsType" maxOccurs="unbounded"/>
  </xs:sequence>
</xs:complexType>
```

UPOZORENJE:

V elementu <cps> je uvijek barem jedan dummy zapis

- Primjer dummy zapis:

CPS_7164 = 1

PCA_7224 = Ako postoje SSCC kodovi za artikle tu je zapisan broj različitih SSCC kodova, inače je vrijednost polja =0

Ostala polja su kod dummy zapisa prazna

- ako postoje SSCC kodovi za artikel

Postoji toliko <cps> elemenata koliko je različitih SSCC kodova – distinct(sscc_koda)

CPS_7164 = red.broj za <cps> element

CPS_7166 = 1 (uvijek veza na dummy zapis)

GIN_7402 = SSCC kod artikla

PCA_7065 = TIP pakiranja

PCA_7224 = prazno

element DESADVcpsType/cps

diagram

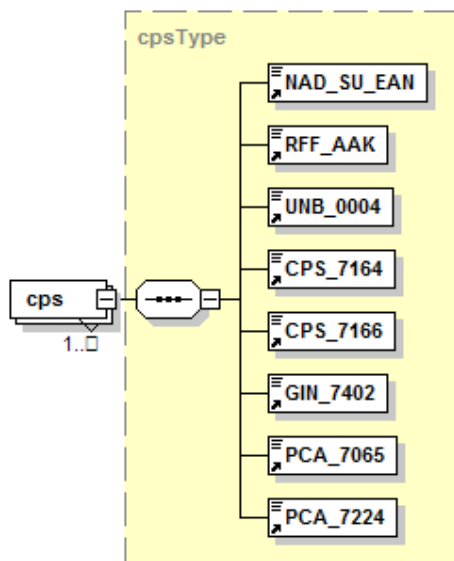

namespace <https://3s.panteon.biz/schemes/desadv>

type [cpsType](#)

properties
isRef 0
minOcc 1
maxOcc unbounded
content complex

children [NAD_SU_EAN](#) [RFF_AAK](#) [UNB_0004](#) [CPS_7164](#) [CPS_7166](#) [GIN_7402](#) [PCA_7065](#) [PCA_7224](#)

source `<xs:element name="cps" type="cpsType" maxOccurs="unbounded"/>`

element DESADVType/DESADVitems

diagram

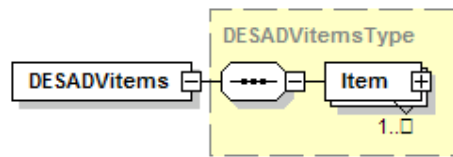

namespace <https://3s.panteon.biz/schemes/desadv>

type [DESADVitemsType](#)

properties
isRef 0
content complex

children [Item](#)

```
source <xs:complexType name="DESADVitemsType">
  <xs:sequence>
    <xs:element name="Item" type="ItemType" maxOccurs="unbounded"/>
  </xs:sequence>
</xs:complexType>
```

element **DESADVitemsType/Item**

diagram

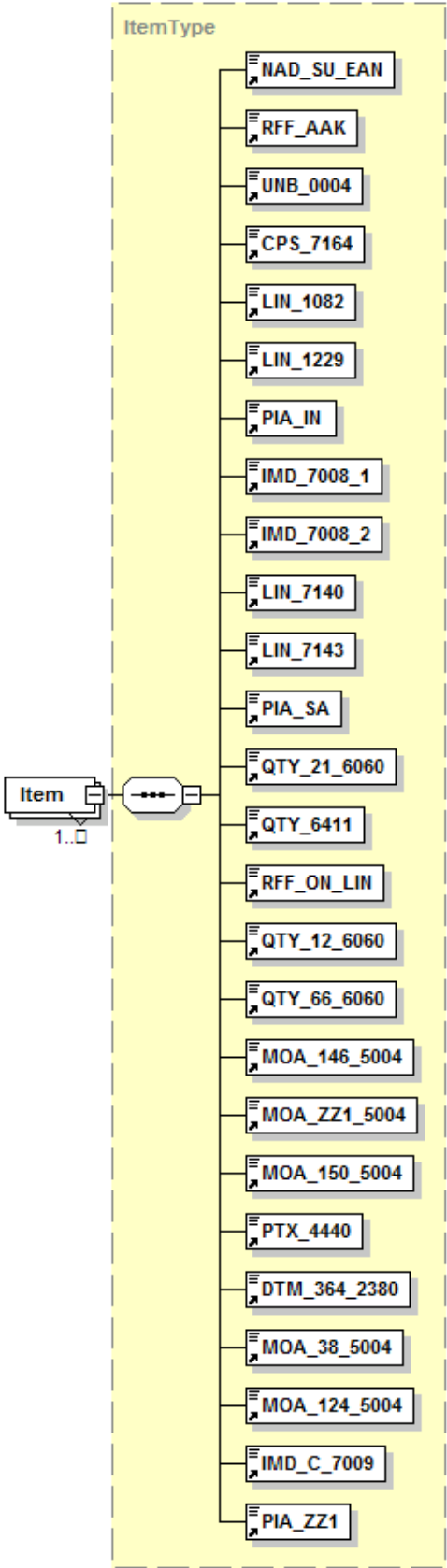

namespace <https://3s.panteon.biz/schemes/desadv>

type [ItemType](#)

properties

isRef	0
minOcc	1
maxOcc	unbounded
content	complex

children [NAD_SU_EAN](#) [RFF_AAK](#) [UNB_0004](#) [CPS_7164](#) [LIN_1082](#) [LIN_1229](#) [PIA_IN](#) [IMD_7008_1](#) [IMD_7008_2](#) [LIN_7140](#) [LIN_7143](#) [PIA_SA](#) [QTY_21](#) [6060_QTY_6411](#) [RFF_ON](#) [LIN_QTY_12](#) [6060_QTY_66](#) [6060_MOA_146](#) [5004](#) [MOA_ZZ1](#) [5004](#) [MOA_150](#) [5004](#) [PTX_4440](#) [DTM_364](#) [2380](#) [MOA_31](#) [5004](#) [MOA_124](#) [5004](#) [IMD_C](#) [7009](#) [PIA_ZZ1](#)

source `<xs:element name="Item" type="ItemType" maxOccurs="unbounded"/>`

element DESADVitemsDetails

diagram

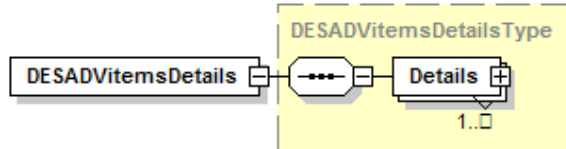

namespace <https://3s.panteon.biz/schemes/desadv>

type [DESADVitemsDetailsType](#)

properties

isRef	0
content	complex

children [Details](#)

source `<xs:element name="DESADVitemsDetails" type="DESADVitemsDetailsType"/>`

element DESADVitemsDetailsType/Details

diagram

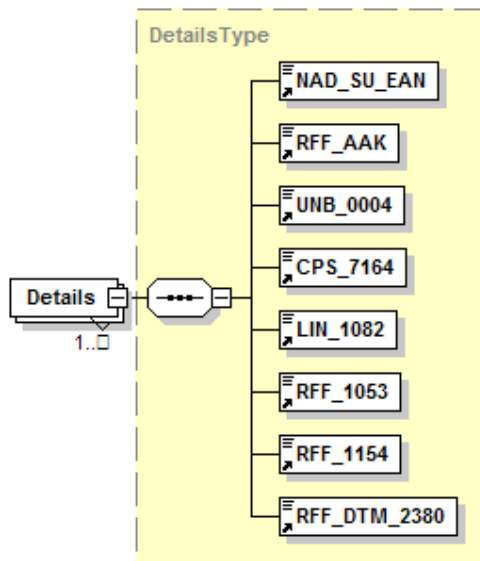

namespace <https://3s.panteon.biz/schemes/desadv>

type [DetailsType](#)

properties

isRef	0
minOcc	0
maxOcc	unbounded
content	complex

children [NAD_SU_EAN](#) [RFF_AAK](#) [UNB_0004](#) [CPS_7164](#) [LIN_1082](#) [RFF_1053](#) [RFF_1154](#) [RFF_DTM_2380](#)

source `<xs:element name="Details" type="DetailsType" minOccurs="0" maxOccurs="unbounded"/>`

4. Opis i značenje polja

element **BGM_1225**

(Funkcija dokumenata - Fixno 9) vrijednost JE obavezna

diagram

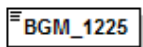

namespace <https://3s.panteon.biz/schemes/desadv>

type **xs:integer**

properties content simple
fixed 9

used by complexType [DESADVHeaderType](#)

source `<xs:element name="BGM_1225" type="xs:integer" fixed="9"/>`

element **CNT_2_6066**

(broj svih pozicija – stavki) vrijednost JE obavezna

diagram

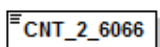

namespace <https://3s.panteon.biz/schemes/desadv>

type **xs:string**

properties content simple

used by complexType [DESADVHeaderType](#)

source `<xs:element name="CNT_2_6066" type="xs:string"/>`

element **CPS_7164**

(Redni broj pakiranja) vrijednost JE obavezna

diagram

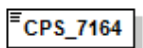

namespace <https://3s.panteon.biz/schemes/desadv>

type **xs:string**

properties content simple

used by complexTypes [cpsType](#) [DetailsType](#) [ItemType](#)

source `<xs:element name="CPS_7164" type="xs:string"/>`

element **CPS_7166**

(Veza na nadređeni zapis) vrijednost JE obavezna samo kod unosa hierarhije pakiranja

diagram

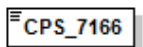

namespace <https://3s.panteon.biz/schemes/desadv>

type **xs:string**

properties content simple

used by complexType [cpsType](#)

source `<xs:element name="CPS_7166" type="xs:string"/>`

element DTM_11

(Predviđeni datum otpreme) vrijednost NIJE obavezna

diagram

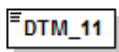

namespace <https://3s.panteon.biz/schemes/desadv>

type **xs:string**

properties content simple

used by complexType [DESADVHeaderType](#)

source `<xs:element name="DTM_11" type="xs:string"/>`

element DTM_137

(Datum dokumenata - dostavnice) vrijednost JE obavezna

diagram

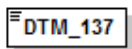

namespace <https://3s.panteon.biz/schemes/desadv>

type **xs:string**

properties content simple

used by complexType [DESADVHeaderType](#)

source `<xs:element name="DTM_137" type="xs:string"/>`

element DTM_17

(Predviđeni datum dostave) vrijednost JE obavezna

diagram

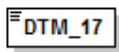

namespace <https://3s.panteon.biz/schemes/desadv>

type **xs:string**

properties content simple

used by complexType [DESADVHeaderType](#)

source `<xs:element name="DTM_17" type="xs:string"/>`

element DTM_364_2380

(Datum upotrabe – Best Before date) vrijednost NIJE obavezna

diagram

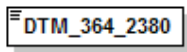

namespace <https://3s.panteon.biz/schemes/desadv>

type **xs:string**

properties content simple

used by complexType [ItemType](#)

source `<xs:element name="DTM_364_2380" type="xs:string"/>`

element **GIN_7402**

(SSCC kod, za jednoličnu oznaku pakiranja) vrijednost NIJE obavezna

diagram

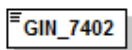

namespace <https://3s.panteon.biz/schemes/desadv>

type **xs:string**

properties content simple

used by complexType [cpsType](#)

source `<xs:element name="GIN_7402" type="xs:string"/>`

element **IMD_7008_1**

(Naziv artikla 1) vrijednost NIJE obavezna

diagram

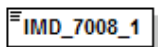

namespace <https://3s.panteon.biz/schemes/desadv>

type **xs:string**

properties content simple

used by complexType [ItemType](#)

source `<xs:element name="IMD_7008_1" type="xs:string"/>`

element **IMD_7008_2**

(Naziv artikla 2) vrijednost NIJE obavezna

diagram

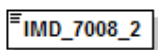

namespace <https://3s.panteon.biz/schemes/desadv>

type **xs:string**

properties content simple

used by complexType [ItemType](#)

source `<xs:element name="IMD_7008_2" type="xs:string"/>`

element **IMD_C_7009**

(Vrsta robe) vrijednost JE obavezna

diagram

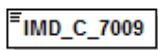

namespace <https://3s.panteon.biz/schemes/desadv>

type **xs:string**

properties content simple

used by complexType [ItemType](#)

source `<xs:element name="IMD_C_7009" type="xs:string"/>`

element LIN_1082

(Redni broj stavke na dostavnici) vrijednost JE obavezna

diagram

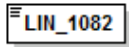

namespace <https://3s.panteon.biz/schemes/desadv>

type **xs:string**

properties content simple

used by complexTypes [DetailsType](#) [ItemType](#)

source `<xs:element name="LIN_1082" type="xs:string"/>`

element LIN_1229

(Funkcija stavke : 1 - stavka je dodana; 3 - stavka promijenjena; 5 - stavka ista kao na ORDERSP) vrijednost JE obavezna

diagram

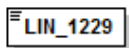

namespace <https://3s.panteon.biz/schemes/desadv>

type **xs:string**

properties content simple

used by complexType [ItemType](#)

source `<xs:element name="LIN_1229" type="xs:string"/>`

element LIN_7140

(EAN ili UPC koda artikla) vrijednost JE obavezna

diagram

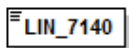

namespace <https://3s.panteon.biz/schemes/desadv>

type **xs:string**

properties content simple

used by complexType [ItemType](#)

source `<xs:element name="LIN_7140" type="xs:string"/>`

element LIN_7143

(Oznaka vrste kode) vrijednost JE obavezna

diagram

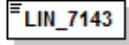

namespace <https://3s.panteon.biz/schemes/desadv>

type **xs:string**

properties content simple

used by complexType [ItemType](#)

source `<xs:element name="LIN_7143" type="xs:string"/>`

element **MOA_124_5004**

(Ukupni iznos poreza) vrijednost NIJE obavezna

diagram

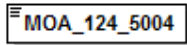

namespace <https://3s.panteon.biz/schemes/desadv>

type **xs:string**

properties content simple

used by complexType [ItemType](#)

source `<xs:element name="MOA_124_5004" type="xs:string"/>`

element **MOA_146_5004**

(Neto cijena) vrijednost NIJE obavezna

diagram

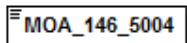

namespace <https://3s.panteon.biz/schemes/desadv>

type **xs:string**

properties content simple

used by complexType [ItemType](#)

source `<xs:element name="MOA_146_5004" type="xs:string"/>`

element **MOA_150_5004**

(Procent poreza) vrijednost NIJE obavezna

diagram

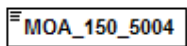

namespace <https://3s.panteon.biz/schemes/desadv>

type **xs:string**

properties content simple

used by complexType [ItemType](#)

source `<xs:element name="MOA_150_5004" type="xs:string"/>`

element **MOA_38_5004**

(Skupni neto iznos) vrijednost NIJE obavezna

diagram

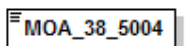

namespace <https://3s.panteon.biz/schemes/desadv>

type **xs:string**

properties content simple

used by complexType [ItemType](#)

source `<xs:element name="MOA_31_5004" type="xs:string"/>`

element **MOA_ZZ1_5004**

(Maloprodajna cijena) vrijednost NIJE obavezna

diagram

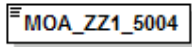

namespace <https://3s.panteon.biz/schemes/desadv>

type **xs:string**

properties content simple

used by complexType [ItemType](#)

source `<xs:element name="MOA_ZZ1_5004" type="xs:string"/>`

element **NAD_BY_EAN**

(GLN kupac - platilac) vrijednost JE obavezna

diagram

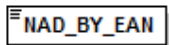

namespace <https://3s.panteon.biz/schemes/desadv>

type **xs:string**

properties content simple

used by complexType [DESADVHeaderType](#)

source `<xs:element name="NAD_BY_EAN" type="xs:string"/>`

element **NAD_BY_NAME**

(Naziv Kupec - platilac) vrijednost NIJE obavezna

Diagram

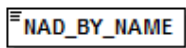

Namespace <https://3s.panteon.biz/schemes/desadv>

Type **xs:string**

Properties content simple

used by complexType [DESADVHeaderType](#)

Source `<xs:element name="NAD_BY_NAME" type="xs:string"/>`

element **NAD_DP_EAN**

(GLN Kupec - dostavno mjesto) vrijednost JE obavezna

diagram

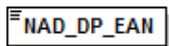

namespace <https://3s.panteon.biz/schemes/desadv>

type **xs:string**

properties content simple

used by complexType [DESADVHeaderType](#)

source `<xs:element name="NAD_DP_EAN" type="xs:string"/>`

element **NAD_DP_NAME**

(Naziv Kupec - dostavno mjesto) vrijednost NIJE obavezna

diagram

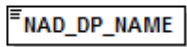

namespace <https://3s.panteon.biz/schemes/desadv>

type **xs:string**

properties content simple

used by complexType [DESADVHeaderType](#)

source `<xs:element name="NAD_DP_NAME" type="xs:string"/>`

element **NAD_OB_EAN**

(GLN Kupec - naručilac) vrijednost NIJE obavezna

diagram

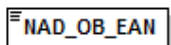

namespace <https://3s.panteon.biz/schemes/desadv>

type **xs:string**

properties content simple

used by complexType [DESADVHeaderType](#)

source `<xs:element name="NAD_OB_EAN" type="xs:string"/>`

element **NAD_OB_NAME**

(Naziv Kupec - naručilac) vrijednost NIJE obavezna

diagram

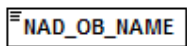

namespace <https://3s.panteon.biz/schemes/desadv>

type **xs:string**

properties content simple

used by complexType [DESADVHeaderType](#)

source `<xs:element name="NAD_OB_NAME" type="xs:string"/>`

element **NAD_SU_EAN**

(GLN Dobavljač – program) vrijednost JE obavezna

diagram

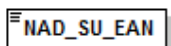

namespace <https://3s.panteon.biz/schemes/desadv>

type **xs:string**

properties content simple

used by complexTypes [cpsType](#) [DESADVHeaderType](#) [DetailsType](#) [ItemType](#)

source `<xs:element name="NAD_SU_EAN" type="xs:string"/>`

element **NAD_SU_NAME**

(Naziv Dobavljač – program) vrijednost NIJE obavezna

diagram

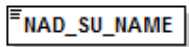

namespace <https://3s.panteon.biz/schemes/desadv>

type **xs:string**

properties content simple

used by complexType [DESADVHeaderType](#)

source `<xs:element name="NAD_SU_NAME" type="xs:string"/>`

element **PCA_7065**

(Tip pakiranja - Šifrant) vrijednost NIJE obavezna

diagram

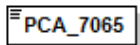

namespace <https://3s.panteon.biz/schemes/desadv>

type **xs:string**

properties content simple

used by complexType [cpsType](#)

source `<xs:element name="PCA_7065" type="xs:string"/>`

element **PCA_7224**

(Broj unutarnje ambalaže) vrijednost NIJE obavezna

diagram

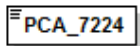

namespace <https://3s.panteon.biz/schemes/desadv>

type **xs:string**

properties content simple

used by complexType [cpsType](#)

source `<xs:element name="PCA_7224" type="xs:string"/>`

element **PIA_ZZ1**

(Nadoknadna EAN koda artikla) vrijednost NIJE obavezna

diagram

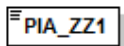

namespace <https://3s.panteon.biz/schemes/desadv>

type **xs:string**

properties content simple

used by complexType [ItemType](#)

source `<xs:element name="PIA_ZZ1" type="xs:string"/>`

element **PIA_IN**

(Kupčeva šifra artikla) vrijednost NIJE obavezna



namespace <https://3s.panteon.biz/schemes/desadv>

type **xs:string**

properties content simple

used by complexType [ItemType](#)

source `<xs:element name="PIA_IN" type="xs:string"/>`

element **PIA_SA**

(Dobavljačeva šifra artikla) vrijednost NIJE obavezna



namespace <https://3s.panteon.biz/schemes/desadv>

type **xs:string**

properties content simple

used by complexType [ItemType](#)

source `<xs:element name="PIA_SA" type="xs:string"/>`

element **PTX_4440**

(Napomena na postavku) vrijednost NIJE obavezna

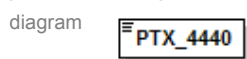

namespace <https://3s.panteon.biz/schemes/desadv>

type **xs:string**

properties content simple

used by complexType [ItemType](#)

source `<xs:element name="PTX_4440" type="xs:string"/>`

element **QTY_12_6060**

(dostavljena količina u enoti naručivanja) vrijednost JE obavezna

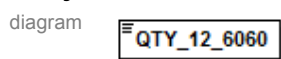

namespace <https://3s.panteon.biz/schemes/desadv>

type **xs:string**

properties content simple

used by complexType [ItemType](#)

source `<xs:element name="QTY_12_6060" type="xs:string"/>`

element QTY_21_6060

(Naručena količina) vrijednost JE obavezna

diagram

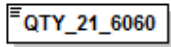

namespace <https://3s.panteon.biz/schemes/desadv>

type **xs:string**

properties content simple

used by complexType [ItemType](#)

source `<xs:element name="QTY_21_6060" type="xs:string"/>`

element QTY_6411

(Jedinica mjere) vrijednost JE obavezna

diagram

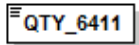

namespace <https://3s.panteon.biz/schemes/desadv>

type **xs:string**

properties content simple

used by complexType [ItemType](#)

source `<xs:element name="QTY_6411" type="xs:string"/>`

element QTY_66_6060

(Potvrđena količina na ORDRSP) vrijednost JE obavezna ako je bio poslan FOR

diagram

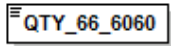

namespace <https://3s.panteon.biz/schemes/desadv>

type **xs:string**

properties content simple

used by complexType [ItemType](#)

source `<xs:element name="QTY_66_6060" type="xs:string"/>`

element RFF_1053

(Tip detalja) vrijednost JE obavezna

diagram

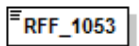

namespace <https://3s.panteon.biz/schemes/desadv>

type **xs:string**

properties content simple

used by complexType [DetailsType](#)

source `<xs:element name="RFF_1053" type="xs:string"/>`

element RFF_1154

(broj detalja) vrijednost JE obavezna

diagram



namespace <https://3s.panteon.biz/schemes/desadv>

type **xs:string**

properties content simple

used by complexType [DetailsType](#)

source `<xs:element name="RFF_1154" type="xs:string"/>`

element RFF_AAK

(Broj dostavnice) vrijednost JE obavezna

diagram

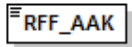

namespace <https://3s.panteon.biz/schemes/desadv>

type **xs:string**

properties content simple

used by complexTypes [cpsType](#) [DESADVHeaderType](#) [DetailsType](#) [ItemType](#)

source `<xs:element name="RFF_AAK" type="xs:string"/>`

element RFF_DQ

(Broj papirnatne dostavnice) vrijednost JE obavezna ako je RFF_DQ <> RFF_AAK

diagram



namespace <https://3s.panteon.biz/schemes/desadv>

type **xs:string**

properties content simple

used by complexType [DESADVHeaderType](#)

source `<xs:element name="RFF_DQ" type="xs:string"/>`

element RFF_DTM_2380

(Datum detalja) vrijednost NIJE obavezna

diagram

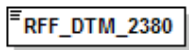

namespace <https://3s.panteon.biz/schemes/desadv>

type **xs:string**

properties content simple

used by complexType [DetailsType](#)

source `<xs:element name="RFF_DTM_2380" type="xs:string"/>`

element **RFF_ON**

(Broj narudžbe) vrijednost JE obavezna – ako se DESADV veže na narudžbo



namespace <https://3s.panteon.biz/schemes/desadv>

type **xs:string**

properties content simple

used by complexType [DESADVHeaderType](#)

source `<xs:element name="RFF_ON" type="xs:string"/>`

element **RFF_ON_DTM**

(Datum narudžbe) vrijednost JE obavezna – ako se DESADV veže na narudžbo



namespace <https://3s.panteon.biz/schemes/desadv>

type **xs:string**

properties content simple

used by complexType [DESADVHeaderType](#)

source `<xs:element name="RFF_ON_DTM" type="xs:string"/>`

element **RFF_ON_LIN**

(Red. broj stavke iz narudžbe) vrijednost JE obavezna – ako se DESADV veže na narudžbo



namespace <https://3s.panteon.biz/schemes/desadv>

type **xs:string**

properties content simple

used by complexType [ItemType](#)

source `<xs:element name="RFF_ON_LIN" type="xs:string"/>`

element **RFF_POR**

(Broj odgovora na narudžbo - FOR) vrijednost JE obavezna – ako je bio poslan FOR



namespace <https://3s.panteon.biz/schemes/desadv>

type **xs:string**

properties content simple

used by complexType [DESADVHeaderType](#)

source `<xs:element name="RFF_POR" type="xs:string"/>`

element **RFF_POR_DTM**

(Datum odgovora na narudžbo - FOR) vrijednost JE obavezna – ako je bio poslan FOR

diagram

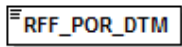

namespace <https://3s.panteon.biz/schemes/desadv>

type **xs:string**

properties content simple

used by complexType [DESADVHeaderType](#)

source `<xs:element name="RFF_POR_DTM" type="xs:string"/>`

element **SEL_9303**

(Ko je plombirao – šifrant) vrijednost NIJE obavezna

diagram

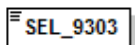

namespace <https://3s.panteon.biz/schemes/desadv>

type **xs:string**

properties content simple

used by complexType [DESADVHeaderType](#)

source `<xs:element name="SEL_9303" type="xs:string"/>`

element **SEL_9308**

(Plomba) vrijednost NIJE obavezna

diagram

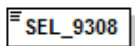

namespace <https://3s.panteon.biz/schemes/desadv>

type **xs:string**

properties content simple

used by complexType [DESADVHeaderType](#)

source `<xs:element name="SEL_9308" type="xs:string"/>`

element **TDT_3127**

(EAN koda prijevoznika) vrijednost NIJE obavezna

diagram

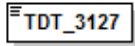

namespace <https://3s.panteon.biz/schemes/desadv>

type **xs:string**

properties content simple

used by complexType [DESADVHeaderType](#)

source `<xs:element name="TDT_3127" type="xs:string"/>`

element TDT_3128

(Naziv prijevoznika) vrijednost NIJE obavezna

diagram

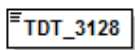

namespace <https://3s.panteon.biz/schemes/desadv>

type **xs:string**

properties content simple

used by complexType [DESADVHeaderType](#)

source `<xs:element name="TDT_3128" type="xs:string"/>`

element TDT_8067

(Način Transporta) vrijednost NIJE obavezna

diagram

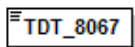

namespace <https://3s.panteon.biz/schemes/desadv>

type **xs:string**

properties content simple

used by complexType [DESADVHeaderType](#)

source `<xs:element name="TDT_8057" type="xs:string"/>`

element TDT_8179

(Tip Transporta) vrijednost NIJE obavezna

diagram

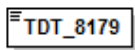

namespace <https://3s.panteon.biz/schemes/desadv>

type **xs:string**

properties content simple

used by complexType [DESADVHeaderType](#)

source `<xs:element name="TDT_8179" type="xs:string"/>`

element TDT_8212

(ID Transporta – broj na reg.tablici) vrijednost NIJE obavezna

diagram

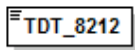

namespace <https://3s.panteon.biz/schemes/desadv>

type **xs:string**

properties content simple

used by complexType [DESADVHeaderType](#)

source `<xs:element name="TDT_8212" type="xs:string"/>`

element **TDT_8453**

(Država ID Transporta) vrijednost NIJE obavezna

diagram

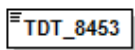

namespace <https://3s.panteon.biz/schemes/desadv>

type **xs:string**

properties content simple

used by complexType [DESADVHeaderType](#)

source `<xs:element name="TDT_8453" type="xs:string"/>`

element **TOD_2_4052**

(Napomena na cjelokupnu dostavnicu) vrijednost NIJE obavezna

diagram

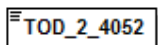

namespace <https://3s.panteon.biz/schemes/desadv>

type **xs:string**

properties content simple

used by complexType [DESADVHeaderType](#)

source `<xs:element name="TOD_2_4052" type="xs:string"/>`

element **TOD_6_4053**

(Način dostave) vrijednost NIJE obavezna

diagram

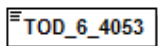

namespace <https://3s.panteon.biz/schemes/desadv>

type **xs:string**

properties content simple

used by complexType [DESADVHeaderType](#)

source `<xs:element name="TOD_6_4053" type="xs:string"/>`

element **UNB_0004**

(GLN kod pošiljatelja dokumenata) vrijednost JE obavezna

diagram

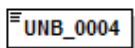

namespace <https://3s.panteon.biz/schemes/desadv>

type **xs:string**

properties content simple

used by complexTypes [cpsType](#) [DESADVHeaderType](#) [DetailsType](#) [ItemType](#)

source `<xs:element name="UNB_0004" type="xs:string"/>`

element UNB_0010

(GLN kod prijemnika dokumenata) vrijednost JE obavezna

diagram

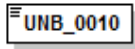

namespace <https://3s.panteon.biz/schemes/desadv>

type **xs:string**

properties content simple

used by complexType [DESADVHeaderType](#)

source `<xs:element name="UNB_0010" type="xs:string"/>`

element UNB_0017

(Datum poruke) vrijednost JE obavezna

diagram

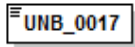

namespace <https://3s.panteon.biz/schemes/desadv>

type **xs:string**

properties content simple

used by complexType [DESADVHeaderType](#)

source `<xs:element name="UNB_0017" type="xs:string"/>`

element UNB_0019

(Ura poruke) vrijednost JE obavezna

diagram

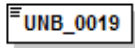

namespace <https://3s.panteon.biz/schemes/desadv>

type **xs:string**

properties content simple

used by complexType [DESADVHeaderType](#)

source `<xs:element name="UNB_0019" type="xs:string"/>`

element UNB_0020

(Broj izmjene za dokument DESADV) vrijednost JE obavezna

diagram

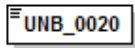

namespace <https://3s.panteon.biz/schemes/desadv>

type **xs:string**

properties content simple

used by complexType [DESADVHeaderType](#)

source `<xs:element name="UNB_0020" type="xs:string"/>`