



Svetovanje in i inženiring na področju elektronskega poslovanja

[www.panteongroup.org](http://www.panteongroup.org)  
[www.panteon.biz](http://www.panteon.biz)

**DOKUMENATACIJA**

**Panteon.biz® DESADV XML 1.00**

<b>REFERENCA</b>	<b>: DESADV_XML_SR</b>
<b>VERZIJA</b>	<b>: 1.0.04</b>
<b>DATUM</b>	<b>: 09. 05. 2006</b>
<b>AVTOR</b>	<b>: PETER</b>

# 1. Saržaj

1. Saržaj.....	2
2. Shema XML dokumenata (Otpremnica).....	3
3. Opis elemenata.....	4
4. Opis i značenje polja.....	14

## 2. Shema XML dokumenata (Otpremnica)

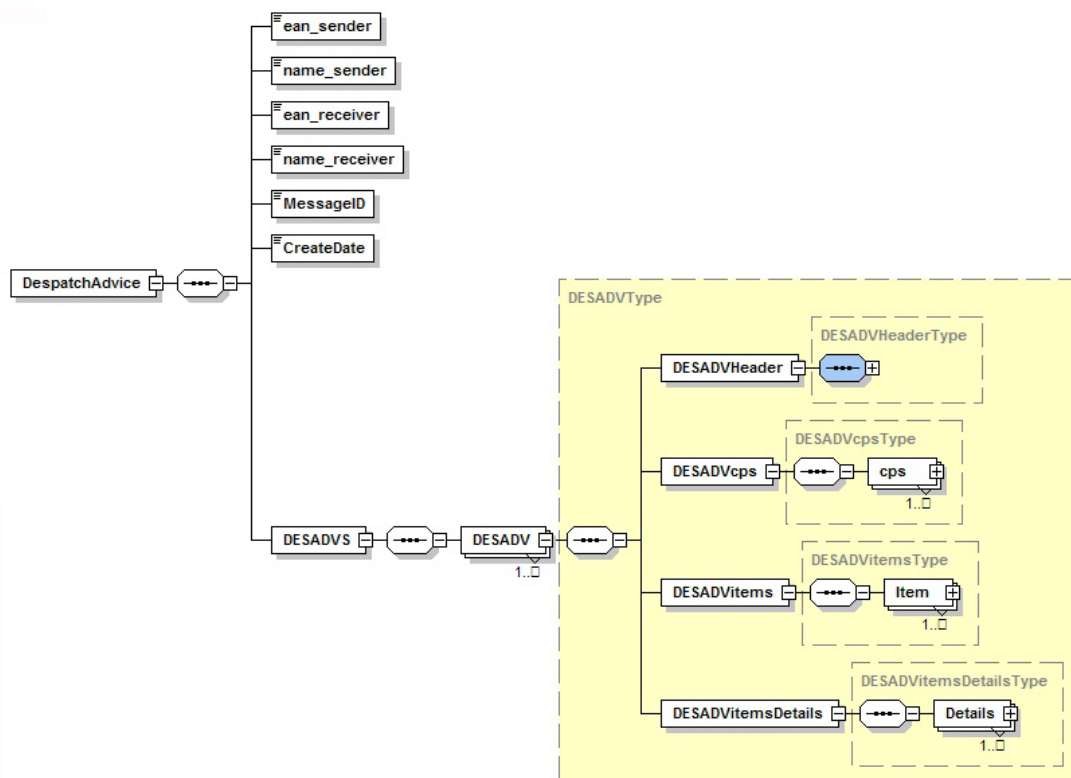

### 3. Opis elemenata

#### element DespatchAdvice

diagram

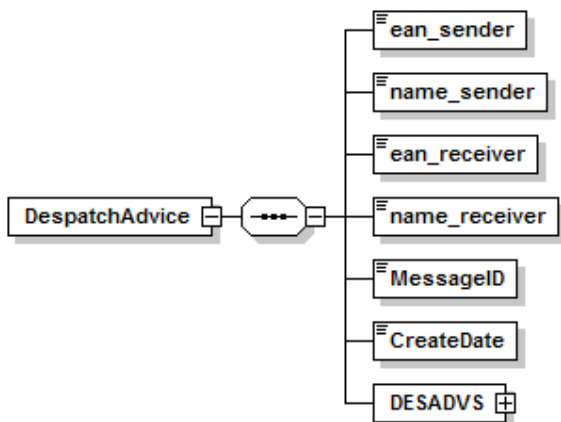

namespace <https://3s.panteon.biz/schemes/desadv>

properties content complex

children [ean\\_sender](#) [name\\_sender](#) [ean\\_receiver](#) [name\\_receiver](#) [MessageID](#) [CreateDate](#) [DESADVS](#)

```
source <xs:element name="DespatchAdvice">
  <xs:complexType>
    <xs:sequence>
      <xs:element name="ean_sender" type="xs:integer"/>
      <xs:element name="name_sender" type="xs:string"/>
      <xs:element name="ean_receiver" type="xs:integer"/>
      <xs:element name="name_receiver" type="xs:string"/>
      <xs:element name="MessageID" type="xs:integer"/>
      <xs:element name="CreateDate" type="xs:string"/>
      <xs:element name="DESADVS">
        <xs:complexType>
          <xs:sequence>
            <xs:element name="DESADV" type="DESADVType" maxOccurs="unbounded"/>
          </xs:sequence>
        </xs:complexType>
      </xs:element>
    </xs:sequence>
  </xs:complexType>
</xs:element>
```

### element **DespatchAdvice/ean\_sender**

(GLN Pošiljatelja XML dokumenata) vrijednost JE obavezna

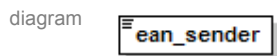

namespace <https://3s.panteon.biz/schemes/desadv>

type **xs:integer**

properties isRef 0  
content simple

source `<xs:element name="ean_sender" type="xs:integer"/>`

### element **DespatchAdvice/name\_sender**

(Naziv Pošiljatelja XML dokumenata) vrijednost JE obavezna

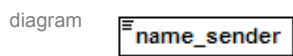

namespace <https://3s.panteon.biz/schemes/desadv>

type **xs:string**

properties isRef 0  
content simple

source `<xs:element name="name_sender" type="xs:string"/>`

### element **DespatchAdvice/ean\_receiver**

(GLN Prijemnika XML dokumenata) vrijednost JE obavezna

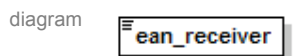

namespace <https://3s.panteon.biz/schemes/desadv>

type **xs:integer**

properties isRef 0  
content simple

source `<xs:element name="ean_receiver" type="xs:integer"/>`

### element **DespatchAdvice/name\_receiver**

(Naziv Prijemnika XML dokumenata) vrijednost JE obavezna

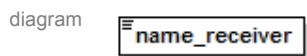

namespace <https://3s.panteon.biz/schemes/desadv>

type **xs:string**

properties isRef 0  
content simple

source `<xs:element name="name_receiver" type="xs:string"/>`

### element **DespatchAdvice/MessageID**

(Broj XML dokumenata) vrijednost JE obavezna



namespace <https://3s.panteon.biz/schemes/desadv>

type **xs:integer**

properties isRef 0  
content simple

source `<xs:element name="MessageID" type="xs:integer"/>`

element **DespatchAdvice/CreateDate**  
(Datum kreiranja XML dokumenata) vrijednost JE obavezna

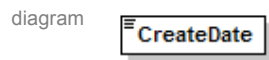

namespace `https://3s.panteon.biz/schemes/desadv`

type **xs:string**

properties      isRef    0  
                 content   simple

source `<xs:element name="CreateDate" type="xs:string"/>`

## element DespatchAdvice/DESADVS

diagram

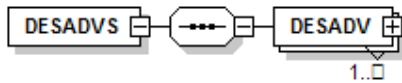

namespace <https://3s.panteon.biz/schemes/desadv>

properties isRef 0  
content complex

children [DESADV](#)

source 

```
<xs:element name="DESADVS">
  <xs:complexType>
    <xs:sequence>
      <xs:element name="DESADV" type="DESADVType" maxOccurs="unbounded"/>
    </xs:sequence>
  </xs:complexType>
</xs:element>
```

## element DespatchAdvice/DESADVS/DESADV

diagram

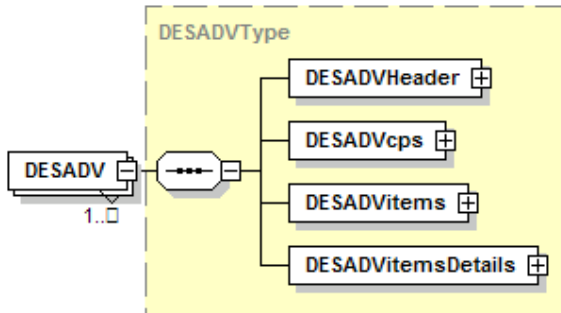

namespace <https://3s.panteon.biz/schemes/desadv>

type [DESADVType](#)

properties isRef 0  
minOcc 1  
maxOcc unbounded  
content complex

children [DESADVHeader](#) [DESADVcps](#) [DESADVitems](#) [DESADVitemsDetails](#)

source 

```
<xs:element name="DESADV" type="DESADVType" maxOccurs="unbounded"/>
```

element **DESADVHeader**

diagram

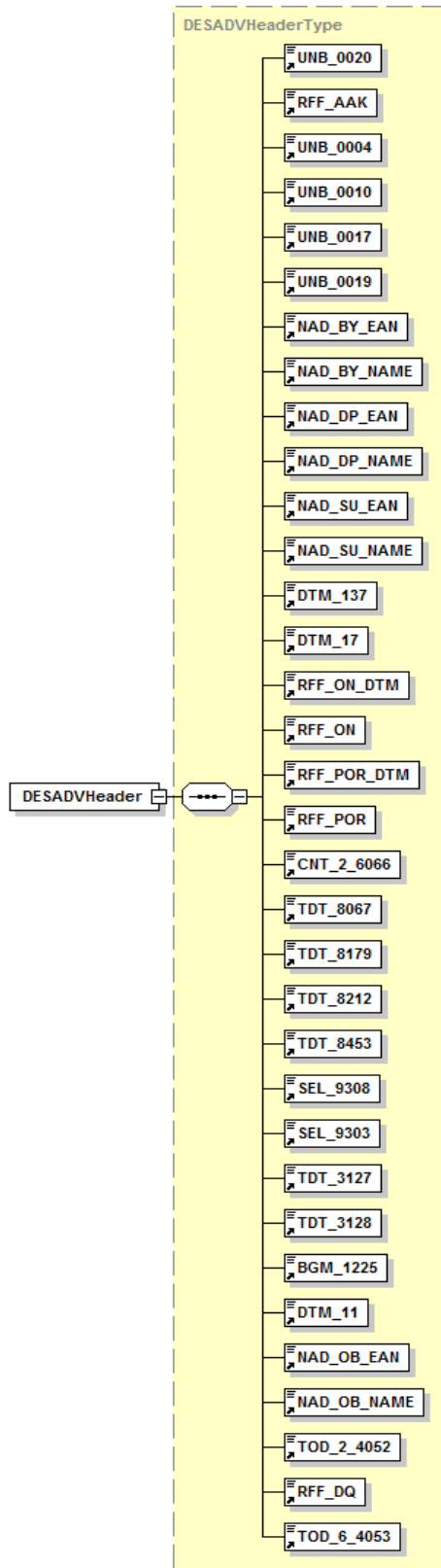

namespace <https://3s.panteon.biz/schemes/desadv>



type [DESADVHeaderType](#)

properties isRef 0  
content complex

children [UNB\\_0020](#) [RFF\\_AAK](#) [UNB\\_0004](#) [UNB\\_0010](#) [UNB\\_0017](#) [UNB\\_0019](#) [NAD\\_BY\\_EAN](#) [NAD\\_BY\\_NAME](#) [NAD\\_DP\\_EAN](#) [NAD\\_DP\\_NAME](#) [NAD\\_SU\\_EAN](#) [NAD\\_SU\\_NAME](#) [DTM\\_137](#) [DTM\\_17](#) [RFF\\_ON\\_DTM](#) [RFF\\_ON](#) [RFF\\_POR\\_DTM](#) [RFF\\_POR](#) [CNT\\_2\\_6066](#) [TDT\\_8057](#) [TDT\\_8179](#) [TDT\\_8212](#) [TDT\\_8453](#) [SEL\\_9308](#) [SEL\\_9303](#) [TDT\\_3127](#) [TDT\\_3128](#) [BGM\\_1225](#) [DTM\\_11](#) [NAD\\_OB\\_EAN](#) [NAD\\_OB\\_NAME](#) [TOD\\_2\\_4052](#) [RFF\\_DQ](#) [TOD\\_6\\_4053](#)

source 

```
<xs:complexType name="DESADVHeaderType">
  <xs:sequence>
    <xs:element ref="UNB_0020"/>
    <xs:element ref="RFF_AAK"/>
    <xs:element ref="UNB_0004"/>
    <xs:element ref="UNB_0010"/>
    <xs:element ref="UNB_0017"/>
    <xs:element ref="UNB_0019"/>
    <xs:element ref="NAD_BY_EAN"/>
    <xs:element ref="NAD_BY_NAME"/>
    <xs:element ref="NAD_DP_EAN"/>
    <xs:element ref="NAD_DP_NAME"/>
    <xs:element ref="NAD_SU_EAN"/>
    <xs:element ref="NAD_SU_NAME"/>
    <xs:element ref="DTM_137"/>
    <xs:element ref="DTM_17"/>
    <xs:element ref="RFF_ON_DTM"/>
    <xs:element ref="RFF_ON"/>
    <xs:element ref="RFF_POR_DTM"/>
    <xs:element ref="RFF_POR"/>
    <xs:element ref="CNT_2_6066"/>
    <xs:element ref="TDT_8057"/>
    <xs:element ref="TDT_8179"/>
    <xs:element ref="TDT_8212"/>
    <xs:element ref="TDT_8453"/>
    <xs:element ref="SEL_9308"/>
    <xs:element ref="SEL_9303"/>
    <xs:element ref="TDT_3127"/>
    <xs:element ref="TDT_3128"/>
    <xs:element ref="BGM_1225"/>
    <xs:element ref="DTM_11"/>
    <xs:element ref="NAD_OB_EAN"/>
    <xs:element ref="NAD_OB_NAME"/>
    <xs:element ref="TOD_2_4052"/>
    <xs:element ref="RFF_DQ"/>
    <xs:element ref="TOD_6_4053"/>
  </xs:sequence>
</xs:complexType>
```

### element **DESADVcps**

diagram

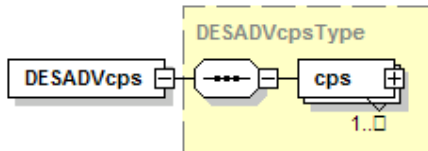

namespace <https://3s.panteon.biz/schemes/desadv>

type [DESADVcpsType](#)

properties isRef 0  
content complex

children [cps](#)

source 

```
<xs:complexType name="DESADVcpsType">
  <xs:sequence>
    <xs:element name="cps" type="cpsType" maxOccurs="unbounded"/>
  </xs:sequence>
</xs:complexType>
```

## UPOZORENJE:

V elementu <cps> je uvijek barem jedan dummy zapis

- Primjer dummy zapis:

CPS\_7164 = 1

PCA\_7224 = Ako postoje SSCC kodovi za artikle tu je zapisan broj različitih SSCC kodova, inače je vrijednost polja =0

Ostala polja su kod dummy zapisa prazna

- ako postoje SSCC kodovi za artikel

Postoji toliko <cps> elemenata koliko je različitih SSCC kodova – distinct(sscc\_koda)

CPS\_7164 = red.broj za <cps> element

CPS\_7166 = 1 (uvijek veza na dummy zapis)

GIN\_7402 = SSCC kod artikla

PCA\_7065 = TIP pakiranja

PCA\_7224 = prazno

## element DESADVcpsType/cps

diagram

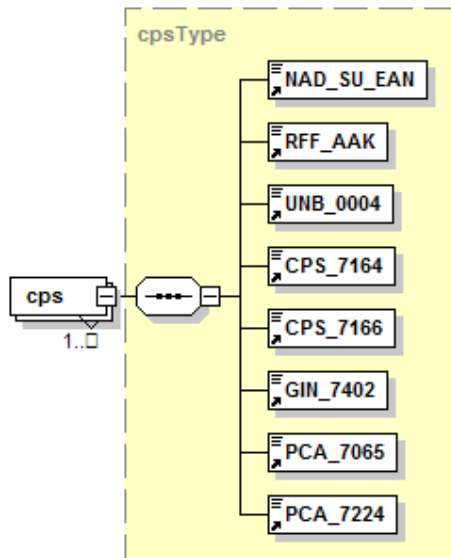

namespace <https://3s.panteon.biz/schemes/desadv>

type [cpsType](#)

properties  
isRef 0  
minOcc 1  
maxOcc unbounded  
content complex

children [NAD\\_SU\\_EAN](#) [RFF\\_AAK](#) [UNB\\_0004](#) [CPS\\_7164](#) [CPS\\_7166](#) [GIN\\_7402](#) [PCA\\_7065](#) [PCA\\_7224](#)

source `<xs:element name="cps" type="cpsType" maxOccurs="unbounded"/>`

## element DESADVType/DESADVitems

diagram

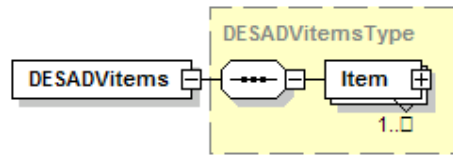

namespace <https://3s.panteon.biz/schemes/desadv>

type [DESADVitemsType](#)

properties  
isRef 0  
content complex

children [Item](#)

```
source <xs:complexType name="DESADVitemsType">
  <xs:sequence>
    <xs:element name="Item" type="ItemType" maxOccurs="unbounded"/>
  </xs:sequence>
</xs:complexType>
```

element **DESADVitemsType/Item**

diagram

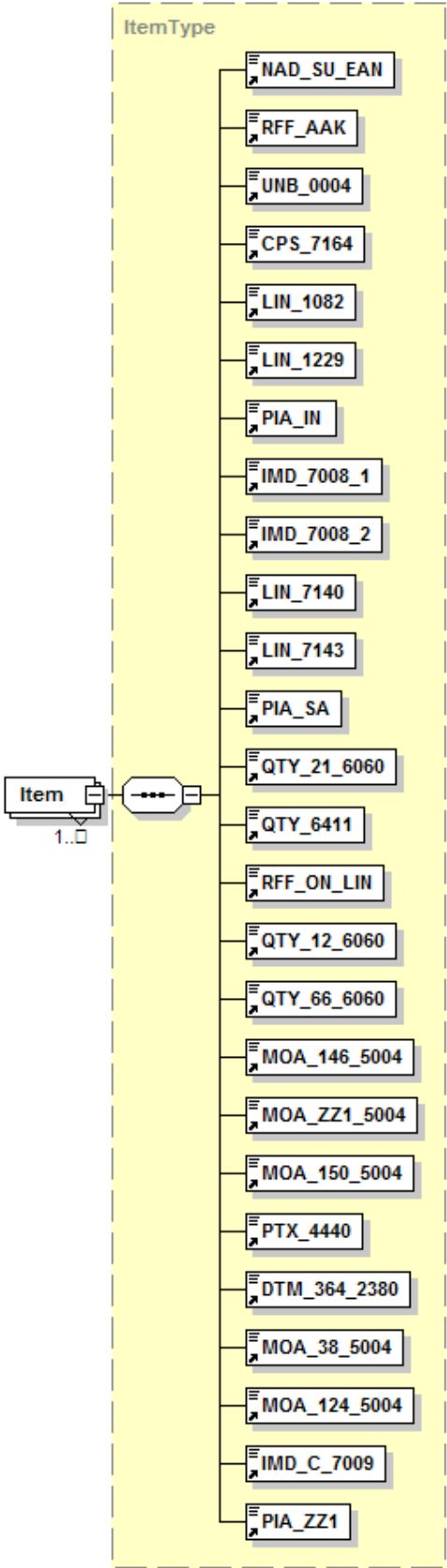

namespace <https://3s.panteon.biz/schemes/desadv>

type [ItemType](#)

properties
 

isRef	0
minOcc	1
maxOcc	unbounded
content	complex

children [NAD\\_SU\\_EAN](#) [RFF\\_AAK](#) [UNB\\_0004](#) [CPS\\_7164](#) [LIN\\_1082](#) [LIN\\_1229](#) [PIA\\_IN](#) [IMD\\_7008\\_1](#) [IMD\\_7008\\_2](#) [LIN\\_7140](#) [LIN\\_7143](#) [PIA\\_SA](#) [QTY\\_21](#) [6060\\_QTY\\_6411](#) [RFF\\_ON](#) [LIN\\_QTY\\_12](#) [6060\\_QTY\\_66](#) [6060\\_MOA\\_146](#) [5004](#) [MOA\\_ZZ1](#) [5004](#) [MOA\\_150](#) [5004](#) [PTX\\_4440](#) [DTM\\_364](#) [2380](#) [MOA\\_31](#) [5004](#) [MOA\\_124](#) [5004](#) [IMD\\_C](#) [7009](#) [PIA\\_ZZ1](#)

source `<xs:element name="Item" type="ItemType" maxOccurs="unbounded"/>`

**element DESADVItemsDetails**

diagram

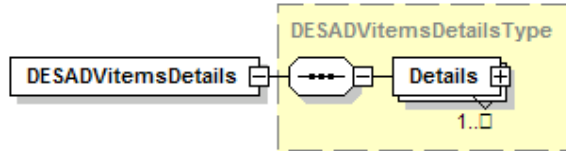

namespace <https://3s.panteon.biz/schemes/desadv>

type [DESADVItemsDetailsType](#)

properties
 

isRef	0
content	complex

children [Details](#)

source `<xs:element name="DESADVItemsDetails" type="DESADVItemsDetailsType"/>`

**element DESADVItemsDetailsType/Details**

diagram

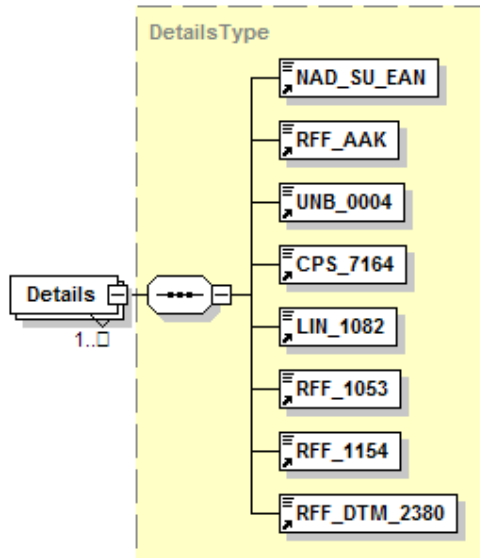

namespace <https://3s.panteon.biz/schemes/desadv>

type [DetailsType](#)

properties
 

isRef	0
minOcc	0
maxOcc	unbounded
content	complex

children [NAD\\_SU\\_EAN](#) [RFF\\_AAK](#) [UNB\\_0004](#) [CPS\\_7164](#) [LIN\\_1082](#) [RFF\\_1053](#) [RFF\\_1154](#) [RFF\\_DTM\\_2380](#)

source `<xs:element name="Details" type="DetailsType" minOccurs="0" maxOccurs="unbounded"/>`

## 4. Opis i značenje polja

### element **BGM\_1225**

(Funkcija dokumenata - Fixno 9) vrijednost JE obavezna

diagram

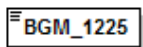

namespace <https://3s.panteon.biz/schemes/desadv>

type **xs:integer**

properties content simple  
fixed 9

used by complexType [DESADVHeaderType](#)

source `<xs:element name="BGM_1225" type="xs:integer" fixed="9"/>`

### element **CNT\_2\_6066**

(broj svih pozicija – stavki) vrijednost JE obavezna

diagram

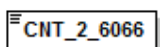

namespace <https://3s.panteon.biz/schemes/desadv>

type **xs:string**

properties content simple

used by complexType [DESADVHeaderType](#)

source `<xs:element name="CNT_2_6066" type="xs:string"/>`

### element **CPS\_7164**

(Redni broj pakiranja) vrijednost JE obavezna

diagram

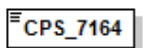

namespace <https://3s.panteon.biz/schemes/desadv>

type **xs:string**

properties content simple

used by complexTypes [cpsType](#) [DetailsType](#) [ItemType](#)

source `<xs:element name="CPS_7164" type="xs:string"/>`

### element **CPS\_7166**

(Veza na nadređeni zapis) vrijednost JE obavezna samo kod unosa hierarhije pakiranja

diagram

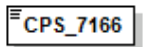

namespace <https://3s.panteon.biz/schemes/desadv>

type **xs:string**

properties content simple

used by complexType [cpsType](#)

source `<xs:element name="CPS_7166" type="xs:string"/>`

#### element DTM\_11

(Predviđeni datum otpreme) vrijednost NIJE obavezna

diagram

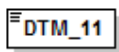

namespace <https://3s.panteon.biz/schemes/desadv>

type **xs:string**

properties content simple

used by complexType [DESADVHeaderType](#)

source `<xs:element name="DTM_11" type="xs:string"/>`

#### element DTM\_137

(Datum dokumenata - dostavnice) vrijednost JE obavezna

diagram

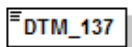

namespace <https://3s.panteon.biz/schemes/desadv>

type **xs:string**

properties content simple

used by complexType [DESADVHeaderType](#)

source `<xs:element name="DTM_137" type="xs:string"/>`

#### element DTM\_17

(Predviđeni datum dostave) vrijednost JE obavezna

diagram

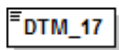

namespace <https://3s.panteon.biz/schemes/desadv>

type **xs:string**

properties content simple

used by complexType [DESADVHeaderType](#)

source `<xs:element name="DTM_17" type="xs:string"/>`

#### element DTM\_364\_2380

(Datum upotrabe – Best Before date) vrijednost NIJE obavezna

diagram

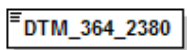

namespace <https://3s.panteon.biz/schemes/desadv>

type **xs:string**

properties content simple

used by complexType [ItemType](#)

source `<xs:element name="DTM_364_2380" type="xs:string"/>`

### element **GIN\_7402**

(SSCC kod, za jednoličnu oznaku pakiranja) vrijednost NIJE obavezna

diagram

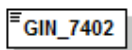

namespace <https://3s.panteon.biz/schemes/desadv>

type **xs:string**

properties content simple

used by complexType [cpsType](#)

source `<xs:element name="GIN_7402" type="xs:string"/>`

### element **IMD\_7008\_1**

(Naziv artikla 1) vrijednost NIJE obavezna

diagram

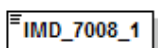

namespace <https://3s.panteon.biz/schemes/desadv>

type **xs:string**

properties content simple

used by complexType [ItemType](#)

source `<xs:element name="IMD_7008_1" type="xs:string"/>`

### element **IMD\_7008\_2**

(Naziv artikla 2) vrijednost NIJE obavezna

diagram

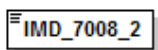

namespace <https://3s.panteon.biz/schemes/desadv>

type **xs:string**

properties content simple

used by complexType [ItemType](#)

source `<xs:element name="IMD_7008_2" type="xs:string"/>`

### element **IMD\_C\_7009**

(Vrsta robe) vrijednost JE obavezna

diagram

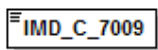

namespace <https://3s.panteon.biz/schemes/desadv>

type **xs:string**

properties content simple

used by complexType [ItemType](#)

source `<xs:element name="IMD_C_7009" type="xs:string"/>`



### element LIN\_1082

(Redni broj stavke na dostavnici) vrijednost JE obavezna

diagram

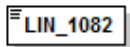

namespace <https://3s.panteon.biz/schemes/desadv>

type **xs:string**

properties content simple

used by complexTypes [DetailsType](#) [ItemType](#)

source `<xs:element name="LIN_1082" type="xs:string"/>`

### element LIN\_1229

(Funkcija stavke : 1 - stavka je dodana; 3 - stavka promijenjena; 5 - stavka ista kao na ORDERS) vrijednost JE obavezna

diagram

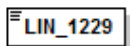

namespace <https://3s.panteon.biz/schemes/desadv>

type **xs:string**

properties content simple

used by complexType [ItemType](#)

source `<xs:element name="LIN_1229" type="xs:string"/>`

### element LIN\_7140

(EAN ili UPC koda artikla) vrijednost JE obavezna

diagram

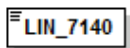

namespace <https://3s.panteon.biz/schemes/desadv>

type **xs:string**

properties content simple

used by complexType [ItemType](#)

source `<xs:element name="LIN_7140" type="xs:string"/>`

### element LIN\_7143

(Oznaka vrste kode) vrijednost JE obavezna

diagram

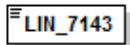

namespace <https://3s.panteon.biz/schemes/desadv>

type **xs:string**

properties content simple

used by complexType [ItemType](#)

source `<xs:element name="LIN_7143" type="xs:string"/>`

### element **MOA\_124\_5004**

(Ukupni iznos poreza) vrijednost NIJE obavezna

diagram

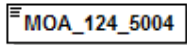

namespace <https://3s.panteon.biz/schemes/desadv>

type **xs:string**

properties content simple

used by complexType [ItemType](#)

source `<xs:element name="MOA_124_5004" type="xs:string"/>`

### element **MOA\_146\_5004**

(Neto cijena) vrijednost NIJE obavezna

diagram

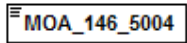

namespace <https://3s.panteon.biz/schemes/desadv>

type **xs:string**

properties content simple

used by complexType [ItemType](#)

source `<xs:element name="MOA_146_5004" type="xs:string"/>`

### element **MOA\_150\_5004**

(Procent poreza) vrijednost NIJE obavezna

diagram

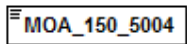

namespace <https://3s.panteon.biz/schemes/desadv>

type **xs:string**

properties content simple

used by complexType [ItemType](#)

source `<xs:element name="MOA_150_5004" type="xs:string"/>`

### element **MOA\_38\_5004**

(Skupni neto iznos) vrijednost NIJE obavezna

diagram

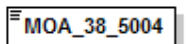

namespace <https://3s.panteon.biz/schemes/desadv>

type **xs:string**

properties content simple

used by complexType [ItemType](#)

source `<xs:element name="MOA_31_5004" type="xs:string"/>`

### element **MOA\_ZZ1\_5004**

(Maloprodajna cijena) vrijednost NIJE obavezna

diagram

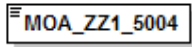

namespace <https://3s.panteon.biz/schemes/desadv>

type **xs:string**

properties content simple

used by complexType [ItemType](#)

source `<xs:element name="MOA_ZZ1_5004" type="xs:string"/>`

### element **NAD\_BY\_EAN**

(GLN kupac - platilac) vrijednost JE obavezna

diagram

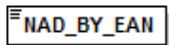

namespace <https://3s.panteon.biz/schemes/desadv>

type **xs:string**

properties content simple

used by complexType [DESADVHeaderType](#)

source `<xs:element name="NAD_BY_EAN" type="xs:string"/>`

### element **NAD\_BY\_NAME**

(Naziv Kupec - platilac) vrijednost NIJE obavezna

Diagram

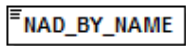

Namespace <https://3s.panteon.biz/schemes/desadv>

Type **xs:string**

Properties content simple

used by complexType [DESADVHeaderType](#)

Source `<xs:element name="NAD_BY_NAME" type="xs:string"/>`

### element **NAD\_DP\_EAN**

(GLN Kupec - dostavno mjesto) vrijednost JE obavezna

diagram

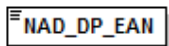

namespace <https://3s.panteon.biz/schemes/desadv>

type **xs:string**

properties content simple

used by complexType [DESADVHeaderType](#)

source `<xs:element name="NAD_DP_EAN" type="xs:string"/>`

### element **NAD\_DP\_NAME**

(Naziv Kupec - dostavno mjesto) vrijednost NIJE obavezna

diagram

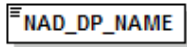

namespace <https://3s.panteon.biz/schemes/desadv>

type **xs:string**

properties content simple

used by complexType [DESADVHeaderType](#)

source `<xs:element name="NAD_DP_NAME" type="xs:string"/>`

### element **NAD\_OB\_EAN**

(GLN Kupec - naručilac) vrijednost NIJE obavezna

diagram

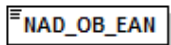

namespace <https://3s.panteon.biz/schemes/desadv>

type **xs:string**

properties content simple

used by complexType [DESADVHeaderType](#)

source `<xs:element name="NAD_OB_EAN" type="xs:string"/>`

### element **NAD\_OB\_NAME**

(Naziv Kupec - naručilac) vrijednost NIJE obavezna

diagram

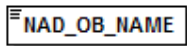

namespace <https://3s.panteon.biz/schemes/desadv>

type **xs:string**

properties content simple

used by complexType [DESADVHeaderType](#)

source `<xs:element name="NAD_OB_NAME" type="xs:string"/>`

### element **NAD\_SU\_EAN**

(GLN Dobavljač – program ) vrijednost JE obavezna

diagram

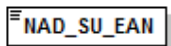

namespace <https://3s.panteon.biz/schemes/desadv>

type **xs:string**

properties content simple

used by complexTypes [cpsType](#) [DESADVHeaderType](#) [DetailsType](#) [ItemType](#)

source `<xs:element name="NAD_SU_EAN" type="xs:string"/>`

### element **NAD\_SU\_NAME**

(Naziv Dobavljač – program ) vrijednost NIJE obavezna

diagram

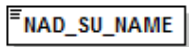

namespace <https://3s.panteon.biz/schemes/desadv>

type **xs:string**

properties content simple

used by complexType [DESADVHeaderType](#)

source `<xs:element name="NAD_SU_NAME" type="xs:string"/>`

### element **PCA\_7065**

(Tip pakiranja - Šifrant) vrijednost NIJE obavezna

diagram

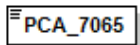

namespace <https://3s.panteon.biz/schemes/desadv>

type **xs:string**

properties content simple

used by complexType [cpsType](#)

source `<xs:element name="PCA_7065" type="xs:string"/>`

### element **PCA\_7224**

(Broj unutarnje ambalaže) vrijednost NIJE obavezna

diagram

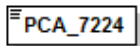

namespace <https://3s.panteon.biz/schemes/desadv>

type **xs:string**

properties content simple

used by complexType [cpsType](#)

source `<xs:element name="PCA_7224" type="xs:string"/>`

### element **PIA\_ZZ1**

(Nadoknadna EAN koda artikla) vrijednost NIJE obavezna

diagram

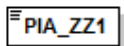

namespace <https://3s.panteon.biz/schemes/desadv>

type **xs:string**

properties content simple

used by complexType [ItemType](#)

source `<xs:element name="PIA_ZZ1" type="xs:string"/>`

### element **PIA\_IN**

(Kupčeva šifra artikla) vrijednost NIJE obavezna



namespace <https://3s.panteon.biz/schemes/desadv>

type **xs:string**

properties content simple

used by complexType [ItemType](#)

source `<xs:element name="PIA_IN" type="xs:string"/>`

### element **PIA\_SA**

(Dobavljačeva šifra artikla) vrijednost NIJE obavezna



namespace <https://3s.panteon.biz/schemes/desadv>

type **xs:string**

properties content simple

used by complexType [ItemType](#)

source `<xs:element name="PIA_SA" type="xs:string"/>`

### element **PTX\_4440**

(Napomena na postavku) vrijednost NIJE obavezna

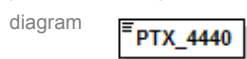

namespace <https://3s.panteon.biz/schemes/desadv>

type **xs:string**

properties content simple

used by complexType [ItemType](#)

source `<xs:element name="PTX_4440" type="xs:string"/>`

### element **QTY\_12\_6060**

(dostavljena količina u enoti naručivanja) vrijednost JE obavezna

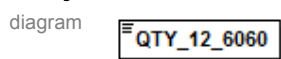

namespace <https://3s.panteon.biz/schemes/desadv>

type **xs:string**

properties content simple

used by complexType [ItemType](#)

source `<xs:element name="QTY_12_6060" type="xs:string"/>`

### element QTY\_21\_6060

(Naručena količina) vrijednost JE obavezna

diagram

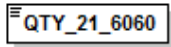

namespace <https://3s.panteon.biz/schemes/desadv>

type **xs:string**

properties content simple

used by complexType [ItemType](#)

source `<xs:element name="QTY_21_6060" type="xs:string"/>`

### element QTY\_6411

(Jedinica mjere) vrijednost JE obavezna

diagram

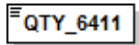

namespace <https://3s.panteon.biz/schemes/desadv>

type **xs:string**

properties content simple

used by complexType [ItemType](#)

source `<xs:element name="QTY_6411" type="xs:string"/>`

### element QTY\_66\_6060

(Potvrđena količina na ORDERSP) vrijednost JE obavezna ako je bio poslan FOR

diagram

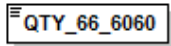

namespace <https://3s.panteon.biz/schemes/desadv>

type **xs:string**

properties content simple

used by complexType [ItemType](#)

source `<xs:element name="QTY_66_6060" type="xs:string"/>`

### element RFF\_1053

(Tip detalja) vrijednost JE obavezna

diagram

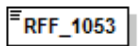

namespace <https://3s.panteon.biz/schemes/desadv>

type **xs:string**

properties content simple

used by complexType [DetailsType](#)

source `<xs:element name="RFF_1053" type="xs:string"/>`

### element RFF\_1154

(broj detalja) vrijednost JE obavezna

diagram

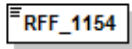

namespace <https://3s.panteon.biz/schemes/desadv>

type **xs:string**

properties content simple

used by complexType [DetailsType](#)

source `<xs:element name="RFF_1154" type="xs:string"/>`

### element RFF\_AAK

(Broj dostavnice) vrijednost JE obavezna

diagram

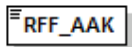

namespace <https://3s.panteon.biz/schemes/desadv>

type **xs:string**

properties content simple

used by complexTypes [cpsType](#) [DESADVHeaderType](#) [DetailsType](#) [ItemType](#)

source `<xs:element name="RFF_AAK" type="xs:string"/>`

### element RFF\_DQ

(Broj papirnatne dostavnice) vrijednost JE obavezna ako je RFF\_DQ <> RFF\_AAK

diagram



namespace <https://3s.panteon.biz/schemes/desadv>

type **xs:string**

properties content simple

used by complexType [DESADVHeaderType](#)

source `<xs:element name="RFF_DQ" type="xs:string"/>`

### element RFF\_DTM\_2380

(Datum detalja) vrijednost NIJE obavezna

diagram

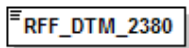

namespace <https://3s.panteon.biz/schemes/desadv>

type **xs:string**

properties content simple

used by complexType [DetailsType](#)

source `<xs:element name="RFF_DTM_2380" type="xs:string"/>`



### element **RFF\_ON**

(Broj narudžbe) vrijednost JE obavezna – ako se DESADV veže na narudžbo

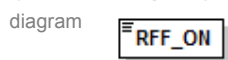

namespace <https://3s.panteon.biz/schemes/desadv>

type **xs:string**

properties content simple

used by complexType [DESADVHeaderType](#)

source `<xs:element name="RFF_ON" type="xs:string"/>`

### element **RFF\_ON\_DTM**

(Datum narudžbe) vrijednost JE obavezna – ako se DESADV veže na narudžbo

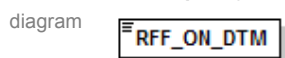

namespace <https://3s.panteon.biz/schemes/desadv>

type **xs:string**

properties content simple

used by complexType [DESADVHeaderType](#)

source `<xs:element name="RFF_ON_DTM" type="xs:string"/>`

### element **RFF\_ON\_LIN**

(Red. broj stavke iz narudžbe) vrijednost JE obavezna – ako se DESADV veže na narudžbo



namespace <https://3s.panteon.biz/schemes/desadv>

type **xs:string**

properties content simple

used by complexType [ItemType](#)

source `<xs:element name="RFF_ON_LIN" type="xs:string"/>`

### element **RFF\_POR**

(Broj odgovora na narudžbo - FOR) vrijednost JE obavezna – ako je bio poslan FOR

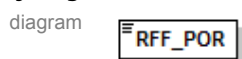

namespace <https://3s.panteon.biz/schemes/desadv>

type **xs:string**

properties content simple

used by complexType [DESADVHeaderType](#)

source `<xs:element name="RFF_POR" type="xs:string"/>`

### element **RFF\_POR\_DTM**

(Datum odgovora na narudžbo - FOR) vrijednost JE obavezna – ako je bio poslan FOR

diagram

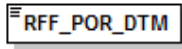

namespace <https://3s.panteon.biz/schemes/desadv>

type **xs:string**

properties content simple

used by complexType [DESADVHeaderType](#)

source `<xs:element name="RFF_POR_DTM" type="xs:string"/>`

### element **SEL\_9303**

(Ko je plombirao – šifrant ) vrijednost NIJE obavezna

diagram

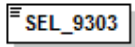

namespace <https://3s.panteon.biz/schemes/desadv>

type **xs:string**

properties content simple

used by complexType [DESADVHeaderType](#)

source `<xs:element name="SEL_9303" type="xs:string"/>`

### element **SEL\_9308**

(Plomba) vrijednost NIJE obavezna

diagram

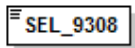

namespace <https://3s.panteon.biz/schemes/desadv>

type **xs:string**

properties content simple

used by complexType [DESADVHeaderType](#)

source `<xs:element name="SEL_9308" type="xs:string"/>`

### element **TDT\_3127**

(EAN koda prijevoznika) vrijednost NIJE obavezna

diagram

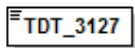

namespace <https://3s.panteon.biz/schemes/desadv>

type **xs:string**

properties content simple

used by complexType [DESADVHeaderType](#)

source `<xs:element name="TDT_3127" type="xs:string"/>`

### element TDT\_3128

(Naziv prijevoznika) vrijednost NIJE obavezna

diagram

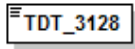

namespace <https://3s.panteon.biz/schemes/desadv>

type **xs:string**

properties content simple

used by complexType [DESADVHeaderType](#)

source `<xs:element name="TDT_3128" type="xs:string"/>`

### element TDT\_8067

(Način Transporta) vrijednost NIJE obavezna

diagram

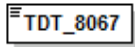

namespace <https://3s.panteon.biz/schemes/desadv>

type **xs:string**

properties content simple

used by complexType [DESADVHeaderType](#)

source `<xs:element name="TDT_8057" type="xs:string"/>`

### element TDT\_8179

(Tip Transporta ) vrijednost NIJE obavezna

diagram

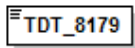

namespace <https://3s.panteon.biz/schemes/desadv>

type **xs:string**

properties content simple

used by complexType [DESADVHeaderType](#)

source `<xs:element name="TDT_8179" type="xs:string"/>`

### element TDT\_8212

(ID Transporta – broj na reg.tablici) vrijednost NIJE obavezna

diagram

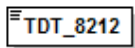

namespace <https://3s.panteon.biz/schemes/desadv>

type **xs:string**

properties content simple

used by complexType [DESADVHeaderType](#)

source `<xs:element name="TDT_8212" type="xs:string"/>`

### element **TDT\_8453**

(Država ID Transporta) vrijednost NIJE obavezna

diagram

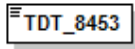

namespace <https://3s.panteon.biz/schemes/desadv>

type **xs:string**

properties content simple

used by complexType [DESADVHeaderType](#)

source `<xs:element name="TDT_8453" type="xs:string"/>`

### element **TOD\_2\_4052**

(Napomena na cjelokupnu dostavnicu) vrijednost NIJE obavezna

diagram

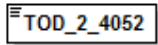

namespace <https://3s.panteon.biz/schemes/desadv>

type **xs:string**

properties content simple

used by complexType [DESADVHeaderType](#)

source `<xs:element name="TOD_2_4052" type="xs:string"/>`

### element **TOD\_6\_4053**

(Način dostave ) vrijednost NIJE obavezna

diagram

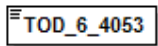

namespace <https://3s.panteon.biz/schemes/desadv>

type **xs:string**

properties content simple

used by complexType [DESADVHeaderType](#)

source `<xs:element name="TOD_6_4053" type="xs:string"/>`

### element **UNB\_0004**

(GLN kod pošiljatelja dokumenata) vrijednost JE obavezna

diagram

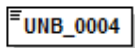

namespace <https://3s.panteon.biz/schemes/desadv>

type **xs:string**

properties content simple

used by complexTypes [cpsType](#) [DESADVHeaderType](#) [DetailsType](#) [ItemType](#)

source `<xs:element name="UNB_0004" type="xs:string"/>`

### element UNB\_0010

(GLN kod prijemnika dokumenata) vrijednost JE obavezna

diagram

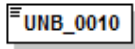

namespace <https://3s.panteon.biz/schemes/desadv>

type **xs:string**

properties content simple

used by complexType [DESADVHeaderType](#)

source `<xs:element name="UNB_0010" type="xs:string"/>`

### element UNB\_0017

(Datum poruke) vrijednost JE obavezna

diagram

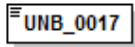

namespace <https://3s.panteon.biz/schemes/desadv>

type **xs:string**

properties content simple

used by complexType [DESADVHeaderType](#)

source `<xs:element name="UNB_0017" type="xs:string"/>`

### element UNB\_0019

(Ura poruke) vrijednost JE obavezna

diagram

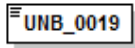

namespace <https://3s.panteon.biz/schemes/desadv>

type **xs:string**

properties content simple

used by complexType [DESADVHeaderType](#)

source `<xs:element name="UNB_0019" type="xs:string"/>`

### element UNB\_0020

(Broj izmjene za dokument DESADV) vrijednost JE obavezna

diagram

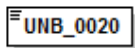

namespace <https://3s.panteon.biz/schemes/desadv>

type **xs:string**

properties content simple

used by complexType [DESADVHeaderType](#)

source `<xs:element name="UNB_0020" type="xs:string"/>`