



Savetovanje i inženiring na području elektronskog poslovanja

www.panteongroup.org
www.panteon.biz

DOKUMENTACIJA

Panteon.biz® ORDERS XML 1.00

REFERENCA	: ORDERS_XML_SR
VERZIJA	: 1.0.03
DATUM	: 31. 08. 2007
AUTOR	: PETER

1. Sadržaj

1. Sadržaj.....	2
2. Shema XML dokumenta (narudžba).....	3
3. Opis elemenata.....	4
4. Opis i značenje polja.....	13

2. Shema XML dokumenta (narudžba)

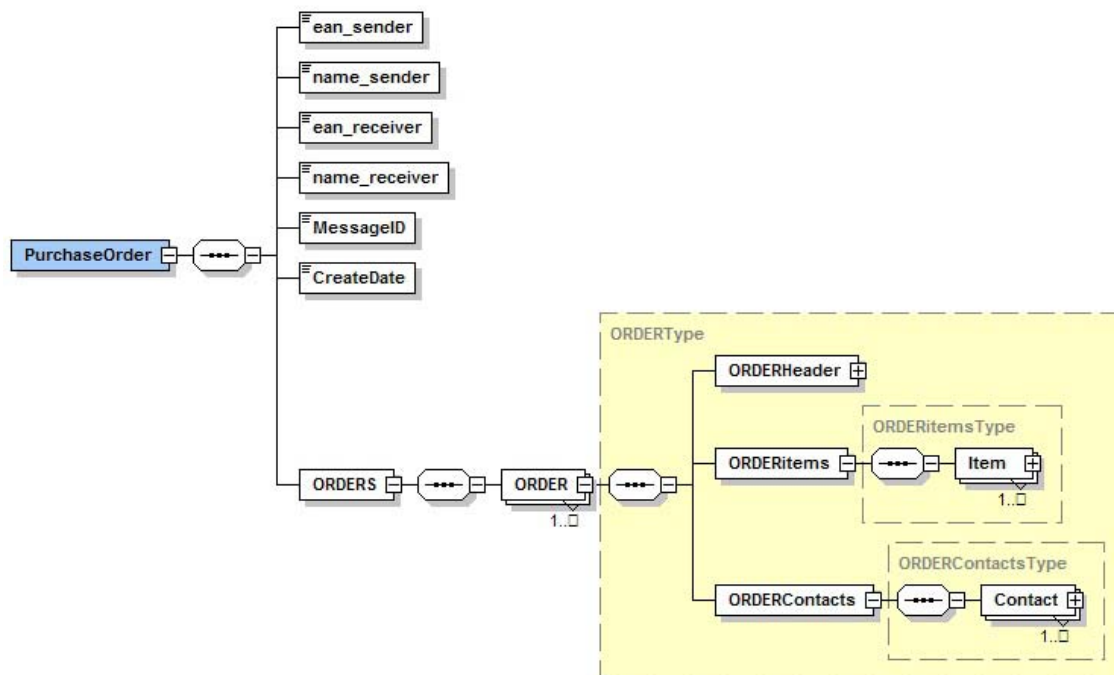

3. Opis elemenata

element PurchaseOrder

diagram

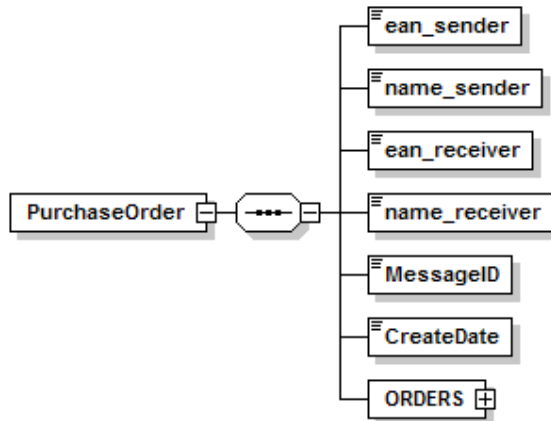

namespace <https://3s.panteon.biz/shemes/orders>

properties content complex

children [ean_sender](#), [name_sender](#), [ean_receiver](#), [name_receiver](#), [MessageID](#), [CreateDate](#),

source

```
<xs:element name="PurchaseOrder">
  <xs:complexType>
    <xs:sequence>
      <xs:element name="ean_sender" type="xs:integer" fixed="3830037200039"/>
      <xs:element name="name_sender" type="xs:string" fixed="Panteon.Biz B2S"/>
      <xs:element name="ean_receiver" type="xs:integer"/>
      <xs:element name="name_receiver" type="xs:string"/>
      <xs:element name="MessageID" type="xs:integer"/>
      <xs:element name="CreateDate" type="xs:string"/>
      <xs:element name="ORDERS">
        <xs:complexType>
          <xs:sequence>
            <xs:element name="ORDER" type="ORDERType" maxOccurs="unbounded"/>
          </xs:sequence>
        </xs:complexType>
      </xs:element>
    </xs:sequence>
  </xs:complexType>
</xs:element>
```

element **PurchaseOrder/ean_sender**

(GLN Pošiljaoca XML dokumenta) vrednost JE obavezna

diagram

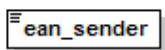

namespace `https://3s.panteon.biz/shemes/orders`

type **xs:integer**

properties
isRef 0
content Simple
fixed 3830037200039

source `<xs:element name="ean_sender" type="xs:integer" fixed="3830037200039"/>`

element **PurchaseOrder/name_sender**

(Naziv Pošiljaoca XML dokumenta) vrednost JE obavezna

diagram

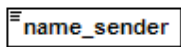

namespace `https://3s.panteon.biz/shemes/orders`

type **xs:string**

properties
isRef 0
content Simple
fixed Panteon.Biz B2S

source `<xs:element name="name_sender" type="xs:string" fixed="Panteon.Biz B2S"/>`

element **PurchaseOrder/ean_receiver**

(GLN Prijemnika XML dokumenta) vrednost JE obavezna

diagram

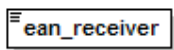

namespace `https://3s.panteon.biz/shemes/orders`

type **xs:integer**

properties
isRef 0
content simple

source `<xs:element name="ean_receiver" type="xs:integer"/>`

element **PurchaseOrder/name_receiver**

(Naziv Prijemnika XML dokumenta) vrednost JE obavezna

diagram

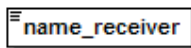

namespace `https://3s.panteon.biz/shemes/orders`

type **xs:string**

properties
isRef 0
content simple

source `<xs:element name="name_receiver" type="xs:string"/>`

element **PurchaseOrder/MessageID**

(Broj XML dokumenta) vrednost JE obavezna

diagram



namespace `https://3s.panteon.biz/shemes/orders`

type **xs:integer**

properties isRef 0
 content simple

source `<xs:element name="MessageID" type="xs:integer"/>`

element **PurchaseOrder/CreateDate**

(Datum nastanka XML dokumenta) vrednost JE obavezna

diagram

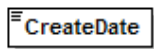

namespace `https://3s.panteon.biz/shemes/orders`

type **xs:string**

properties isRef 0
 content simple

source `<xs:element name="CreateDate" type="xs:string"/>`

element PurchaseOrder/ORDERS

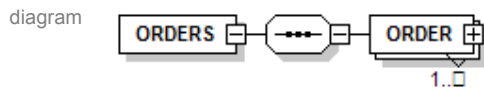

namespace <https://3s.panteon.biz/shemes/orders>

properties isRef 0
content complex

children [ORDER](#)

source

```
<xs:element name="ORDERS">
  <xs:complexType>
    <xs:sequence>
      <xs:element name="ORDER" type="ORDERType" maxOccurs="unbounded"/>
    </xs:sequence>
  </xs:complexType>
</xs:element>
```

element PurchaseOrder/ORDERS/ORDER

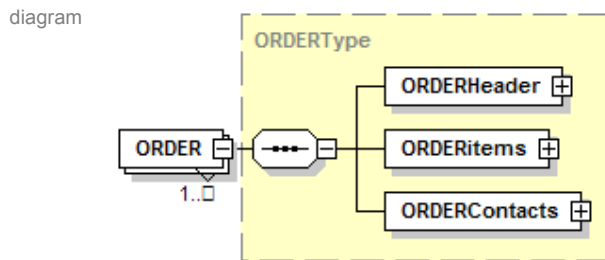

namespace <https://3s.panteon.biz/shemes/orders>

properties isRef 0
minOcc 1
maxOcc Unbounded
content Complex

children [ORDERHeader](#), [ORDERItems](#), [ORDERContacts](#)

source

```
<xs:element name="ORDER" type="ORDERType" maxOccurs="unbounded"/>
```

complexType **ORDERHeaderType**

diagram

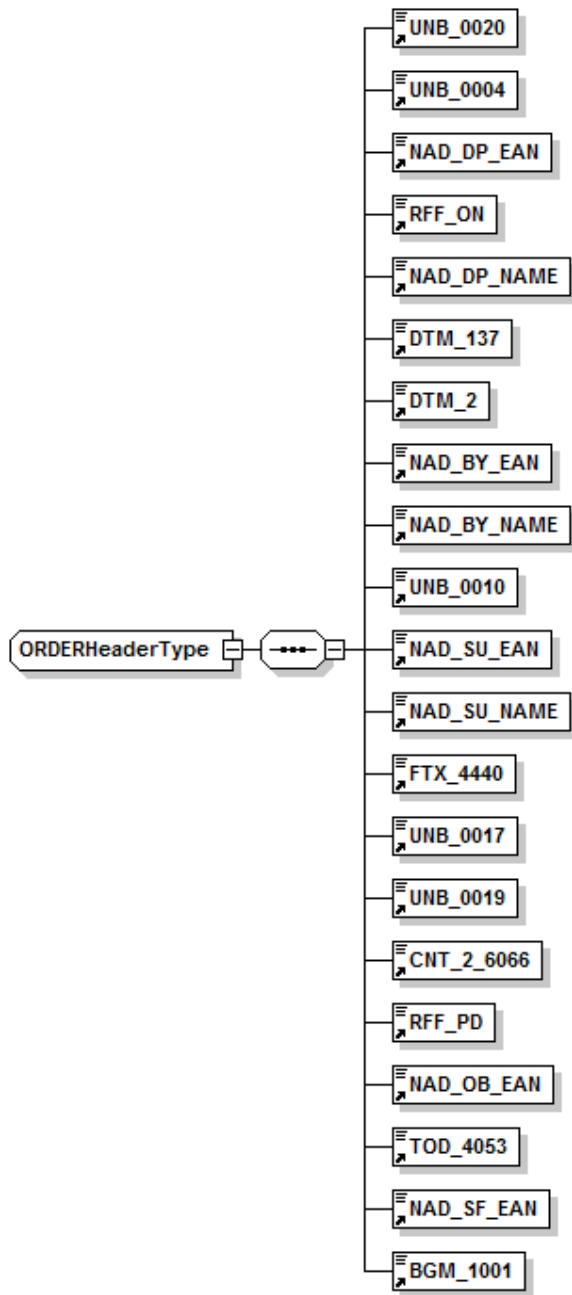

namespace <https://3s.panteon.biz/shemes/orders>

children [UNB_0020](#) [UNB_0004](#) [NAD_DP_EAN](#) [RFF_ON](#) [NAD_DP_NAME](#) [DTM_137](#) [DTM_2](#) [NAD_BY_EAN](#) [NAD_BY_NAME](#) [UNB_0010](#) [NAD_SU_EAN](#) [NAD_SU_NAME](#) [FTX_4440](#) [UNB_0017](#) [UNB_0019](#) [CNT_2_6066](#) [RFF_PD](#) [NAD_OB_EAN](#) [TOD_4053](#) [NAD_SF_EAN](#) [BGM_1001](#)

used by element **ORDERType/ORDERHeader**

```
source <xs:complexType name="ORDERHeaderType">
  <xs:sequence>
    <xs:element ref="UNB_0020"/>
    <xs:element ref="UNB_0004"/>
    <xs:element ref="NAD_DP_EAN"/>
    <xs:element ref="RFF_ON"/>
    <xs:element ref="NAD_DP_NAME"/>
    <xs:element ref="DTM_137"/>
    <xs:element ref="DTM_2"/>
```



```
<xs:element ref="NAD_BY_EAN"/>
<xs:element ref="NAD_BY_NAME"/>
<xs:element ref="UNB_0010"/>
<xs:element ref="NAD_SU_EAN"/>
<xs:element ref="NAD_SU_NAME"/>
<xs:element ref="FTX_4440"/>
<xs:element ref="UNB_0017"/>
<xs:element ref="UNB_0019"/>
<xs:element ref="CNT_2_6066"/>
<xs:element ref="RFF_PD"/>
<xs:element ref="NAD_OB_EAN"/>
<xs:element ref="TOD_4053"/>
<xs:element ref="NAD_SF_EAN"/>
<xs:element ref="BGM_1001"/>
</xs:sequence>
</xs:complexType>
```

complexType ORDERitemsType

diagram

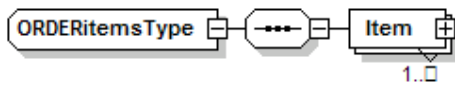

namespace <https://3s.panteon.biz/shemes/orders>

used by element **ORDERType/ORDERitems**

```
<xs:complexType name="ORDERitemsType">  
  <xs:sequence>  
    <xs:element name="Item" type="ItemType" maxOccurs="unbounded"/>  
  </xs:sequence>  
</xs:complexType>
```

complexType ItemType

diagram

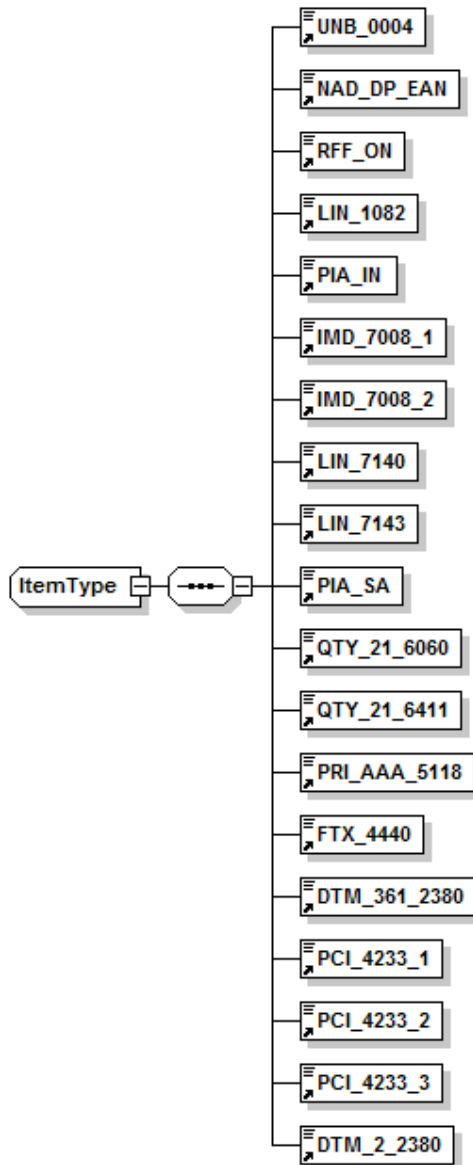

namespace <https://3s.panteon.biz/shemes/orders>

children [UNB_0004](#) [NAD_DP_EAN](#) [RFF_ON](#) [LIN_1082](#) [PIA_IN](#) [IMD_7008_1](#) [IMD_7008_2](#) [LIN_7140](#) [LIN_7143](#) [PIA_SA](#) [QTY_21_6060](#) [QTY_21_6411](#) [PRI_AAA_5118](#) [FTX_4440](#) [DTM_361_2380](#) [PCI_4233_1](#) [PCI_4233_2](#) [PCI_4233_3](#) [DTM_2_2380](#)

used by element **ORDERItemsType/Item**

```
source <xs:complexType name="ItemType">
  <xs:sequence>
    <xs:element ref="UNB_0004"/>
    <xs:element ref="NAD_DP_EAN"/>
    <xs:element ref="RFF_ON"/>
    <xs:element ref="LIN_1082"/>
    <xs:element ref="PIA_IN"/>
    <xs:element ref="IMD_7008_1"/>
    <xs:element ref="IMD_7008_2"/>
    <xs:element ref="LIN_7140"/>
    <xs:element ref="LIN_7143"/>
    <xs:element ref="PIA_SA"/>
    <xs:element ref="QTY_21_6060"/>
    <xs:element ref="QTY_21_6411"/>
    <xs:element ref="PRI_AAA_5118"/>
    <xs:element ref="FTX_4440"/>
    <xs:element ref="DTM_361_2380"/>
    <xs:element ref="PCI_4233_1"/>
    <xs:element ref="PCI_4233_2"/>
    <xs:element ref="PCI_4233_3"/>
    <xs:element ref="DTM_2_2380"/>
  </xs:sequence>
</xs:complexType>
```

complexType ORDERContactsType

diagram

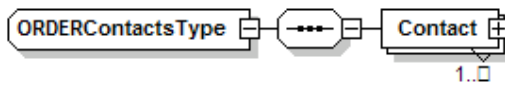

namespace <https://3s.panteon.biz/shemes/orders>

used by element **ORDERType/ORDERContacts**

```
<xs:complexType name="ORDERContactsType">  
  <xs:sequence>  
    <xs:element name="Contact" type="ContactType" maxOccurs="unbounded"/>  
  </xs:sequence>  
</xs:complexType>
```

complexType ContactType

diagram

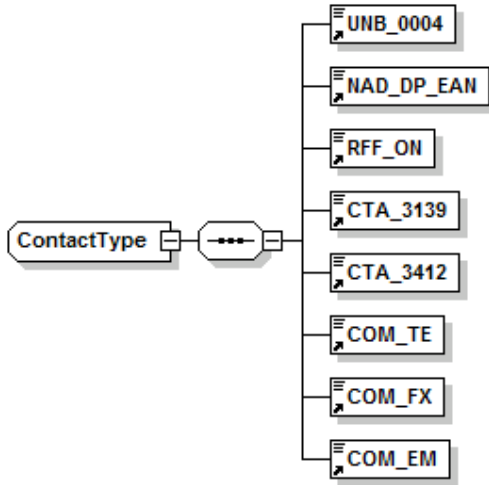

namespace <https://3s.panteon.biz/shemes/orders>

children [UNB_0004](#) [NAD_DP_EAN](#) [RFF_ON](#) [CTA_3139](#) [CTA_3412](#) [COM_TE](#) [COM_FX](#) [COM_EM](#)

used by element **ORDERContactsType/Contact**

```
<xs:complexType name="ContactType">  
  <xs:sequence>  
    <xs:element ref="UNB_0004"/>  
    <xs:element ref="NAD_DP_EAN"/>  
    <xs:element ref="RFF_ON"/>  
    <xs:element ref="CTA_3139"/>  
    <xs:element ref="CTA_3412"/>  
    <xs:element ref="COM_TE"/>  
    <xs:element ref="COM_FX"/>  
    <xs:element ref="COM_EM"/>  
  </xs:sequence>  
</xs:complexType>
```

4. Opis i značenje polja

BGM_1001

(Tip narudžbe / 220 – obična narudžba ; 227 – konsignacijska narudžba) vrednost NIJE obavezna

diagram

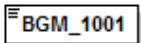

namespace <https://3s.panteon.biz/shemes/orders>

type **xs:string**

properties content Simple

used by complexType [ORDERHeaderType](#)

source `<xs:element name="BGM_1001" type="xs:string"/>`

CNT_2_6066

(Broj svih pozicija –artikala na narudžbi) vrednost JE obavezna

diagram

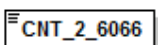

namespace <https://3s.panteon.biz/shemes/orders>

type **xs:string**

properties content simple

used by complexType [ORDERHeaderType](#)

source `<xs:element name="CNT_2_6066" type="xs:string"/>`

COM_EM

(EMAIL adresa kontaktne osobe) vrednost NIJE obavezna

diagram

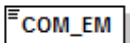

namespace <https://3s.panteon.biz/shemes/orders>

type **xs:string**

properties content simple

used by complexType [ContactType](#)

source `<xs:element name="COM_EM" type="xs:string"/>`

COM_FX

(Fax broj kontaktne osobe) vrednost NIJE obavezna

diagram

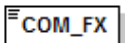

namespace <https://3s.panteon.biz/shemes/orders>

type **xs:string**

properties content simple

used by complexType [ContactType](#)

source `<xs:element name="COM_FX" type="xs:string"/>`

COM_TE

(Telefonski broj kontaktne osobe) vrednost NIJE obavezna

diagram

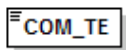

namespace <https://3s.panteon.biz/shemes/orders>

type **xs:string**

properties content simple

used by complexType [ContactType](#)

source `<xs:element name="COM_TE" type="xs:string"/>`

CTA_3139

(Funkcija kontaktne osobe – EANCOM 3139) vrednost NIJE obavezna

diagram

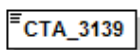

namespace <https://3s.panteon.biz/shemes/orders>

type **xs:string**

properties content simple

used by complexType [ContactType](#)

source `<xs:element name="CTA_3139" type="xs:string"/>`

CTA_3412

(Ime i prezime kontaktne osobe) vrednost JE obavezna

diagram

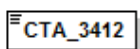

namespace <https://3s.panteon.biz/shemes/orders>

type **xs:string**

properties content simple

used by complexType [ContactType](#)

source `<xs:element name="CTA_3412" type="xs:string"/>`

DTM_137

(Datum narudžbe – format YYYY-MM-DD HH:MI) vrednost JE obavezna

diagram

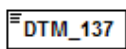

namespace <https://3s.panteon.biz/shemes/orders>

type **xs:string**

properties content simple

used by complexType [ORDERHeaderType](#)

source `<xs:element name="DTM_137" type="xs:string"/>`

DTM_2

(Datum predviđene dostave – format YYYY-MM-DD HH:MI) vrednost JE obavezna



namespace <https://3s.panteon.biz/shemes/orders>
type **xs:string**
properties content simple
used by complexType [ORDERHeaderType](#)
source `<xs:element name="DTM_2" type="xs:string"/>`

DTM_2_2380

(Datum željene dostave (**Billa**) – format YYYY-MM-DD) vrednost NIJE obavezna



namespace <https://3s.panteon.biz/shemes/orders>
type **xs:string**
properties content simple
used by complexType [ItemType](#)
source `<xs:element name="DTM_2_2380" type="xs:string"/>`

DTM_361_2380

(Željeni datum trajanja – format YYYY-MM-DD) vrednost NIJE obavezna

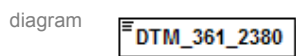

namespace <https://3s.panteon.biz/shemes/orders>
type **xs:string**
properties content simple
used by complexType [ItemType](#)
source `<xs:element name="DTM_361_2380" type="xs:string"/>`

FTX_4440

(Napomena) vrednost NIJE obavezna



namespace <https://3s.panteon.biz/shemes/orders>
type **xs:string**
properties content simple
used by complexTypes [ItemType](#) , [ORDERHeaderType](#)
source `<xs:element name="FTX_4440" type="xs:string"/>`

IMD_7008_1

(Naziv artikla #1) vrednost NIJE obavezna

diagram

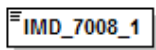

namespace <https://3s.panteon.biz/shemes/orders>

type **xs:string**

properties content simple

used by complexType [ItemType](#)

source `<xs:element name="IMD_7008_1" type="xs:string"/>`

IMD_7008_2

(Naziv artikla #2) vrednost NIJE obavezna

diagram

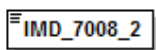

namespace <https://3s.panteon.biz/shemes/orders>

type **xs:string**

properties content simple

used by complexType [ItemType](#)

source `<xs:element name="IMD_7008_2" type="xs:string"/>`

LIN_1082

(Redni broj pozicije – artikla na narudžbi) vrednost JE obavezna

diagram

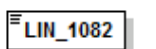

namespace <https://3s.panteon.biz/shemes/orders>

type **xs:string**

properties content simple

used by complexType [ItemType](#)

source `<xs:element name="LIN_1082" type="xs:string"/>`

LIN_7140

(EAN kod artikla) vrednost JE obavezna

diagram

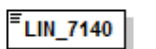

namespace <https://3s.panteon.biz/shemes/orders>

type **xs:string**

properties content simple

used by complexType [ItemType](#)

source `<xs:element name="LIN_7140" type="xs:string"/>`

LIN_7143

(Oznaka vrste koda) vrednost JE obavezna

diagram

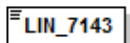

namespace <https://3s.panteon.biz/shemes/orders>

type **xs:string**

properties content simple

used by complexType [ItemType](#)

source `<xs:element name="LIN_7143" type="xs:string"/>`

NAD_BY_EAN

(GLN kupac -platioc) vrednost JE obavezna

diagram

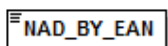

namespace <https://3s.panteon.biz/shemes/orders>

type **xs:string**

properties content simple

used by complexType [ORDERHeaderType](#)

source `<xs:element name="NAD_BY_EAN" type="xs:string"/>`

NAD_BY_NAME

(Naziv kupca - platioc) vrednost NIJE obavezna

diagram

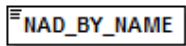

namespace <https://3s.panteon.biz/shemes/orders>

type **xs:string**

properties content simple

used by complexType [ORDERHeaderType](#)

source `<xs:element name="NAD_BY_NAME" type="xs:string"/>`

NAD_DP_EAN

(GLN kupac – dostavno mesto) vrednost JE obavezna

diagram

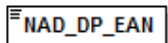

namespace <https://3s.panteon.biz/shemes/orders>

type **xs:string**

properties content simple

used by complexTypes [ContactType](#) [ItemType](#) [ORDERHeaderType](#)

source `<xs:element name="NAD_DP_EAN" type="xs:string"/>`

NAD_DP_NAME

(Naziv kupac – dostavno mesto) vrednost NIJE obavezna

diagram

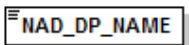

namespace <https://3s.panteon.biz/shemes/orders>

type **xs:string**

properties content simple

used by complexType [ORDERHeaderType](#)

source `<xs:element name="NAD_DP_NAME" type="xs:string"/>`

NAD_OB_EAN

(GLN kupac - naručnik) vrednost NIJE obavezna

diagram

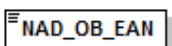

namespace <https://3s.panteon.biz/shemes/orders>

type **xs:string**

properties content simple

used by complexType [ORDERHeaderType](#)

source `<xs:element name="NAD_OB_EAN" type="xs:string"/>`

NAD_SF_EAN

(GLN dobavljača – tvornica "Ship from") vrednost NIJE obavezna

diagram

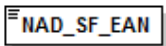

namespace <https://3s.panteon.biz/shemes/orders>

type **xs:string**

properties content simple

used by complexType [ORDERHeaderType](#)

source `<xs:element name="NAD_SF_EAN" type="xs:string"/>`

NAD_SU_EAN

(GLN dobavljača - program) vrednost JE obavezna

U primeru, da dobavljač nema programa se upiše GLN dobavljača

diagram

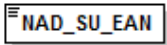

namespace <https://3s.panteon.biz/shemes/orders>

type **xs:string**

properties content simple

used by complexType [ORDERHeaderType](#)

source `<xs:element name="NAD_SU_EAN" type="xs:string"/>`

NAD_SU_NAME

(Naziv dobavljača - program) vrednost NIJE obavezna

diagram

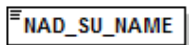

namespace <https://3s.panteon.biz/shemes/orders>

type **xs:string**

properties content simple

used by complexType [ORDERHeaderType](#)

source `<xs:element name="NAD_SU_NAME" type="xs:string"/>`

PCI_4233_1

(Zahtev za posebnu oznaku na omotu #1 – EANCOM 4233) vrednost NIJE obavezna

diagram

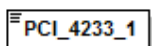

namespace <https://3s.panteon.biz/shemes/orders>

type **xs:string**

properties content simple

used by complexType [ItemType](#)

source `<xs:element name="PCI_4233_1" type="xs:string"/>`

PCI_4233_2

(Zahtev za posebnu oznaku na omotu #2 – EANCOM 4233) vrednost NIJE obavezna

diagram

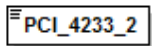

namespace <https://3s.panteon.biz/shemes/orders>

type **xs:string**

properties content simple

used by complexType [ItemType](#)

source `<xs:element name="PCI_4233_2" type="xs:string"/>`

PCI_4233_3

(Zahtev za posebnu oznaku na omotu #3 – EANCOM 4233) vrednost NIJE obavezna

diagram

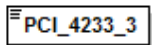

namespace <https://3s.panteon.biz/shemes/orders>

type **xs:string**

properties content simple

used by complexType [ItemType](#)

source `<xs:element name="PCI_4233_3" type="xs:string"/>`

PIA_IN

(EAN kod artikla – interni kod kupca) vrednost NIJE obavezna



namespace <https://3s.panteon.biz/shemes/orders>

type **xs:string**

properties content simple

used by complexType [ItemType](#)

source `<xs:element name="PIA_IN" type="xs:string"/>`

PIA_SA

(EAN kod artikla – dobavljačev kod) vrednost NIJE obavezna

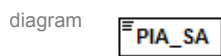

namespace <https://3s.panteon.biz/shemes/orders>

type **xs:string**

properties content simple

used by complexType [ItemType](#)

source `<xs:element name="PIA_SA" type="xs:string"/>`

PRI_AAA_5118

(NETO cena) vrednost NIJE obavezna

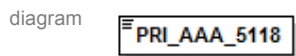

namespace <https://3s.panteon.biz/shemes/orders>

type **xs:string**

properties content simple

used by complexType [ItemType](#)

source `<xs:element name="PRI_AAA_5118" type="xs:string"/>`

QTY_21_6060

(Naručena količina) vrednost JE obavezna

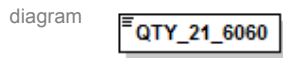

namespace <https://3s.panteon.biz/shemes/orders>

type **xs:string**

properties content simple

used by complexType [ItemType](#)

source `<xs:element name="QTY_21_6060" type="xs:string"/>`

QTY_21_6411

(Jedinica mere – EANCOM 6411) vrednost JE obavezna

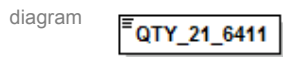

namespace <https://3s.panteon.biz/shemes/orders>

type **xs:string**

properties content simple

used by complexType [ItemType](#)

source `<xs:element name="QTY_21_6411" type="xs:string"/>`

RFF_ON

(broj narudžbe) vrednost JE obavezna



namespace <https://3s.panteon.biz/shemes/orders>

type **xs:string**

properties content simple

used by complexTypes [ContactType](#) [ItemType](#) [ORDERHeaderType](#)

source `<xs:element name="RFF_ON" type="xs:string"/>`

RFF_PD

(Broj promocije) vrednost NIJE obavezna



namespace <https://3s.panteon.biz/shemes/orders>

type **xs:string**

properties content simple

used by complexType [ORDERHeaderType](#)

source `<xs:element name="RFF_PD" type="xs:string"/>`

TOD_4053

(Način dostave – EANCOM 4053) vrednost NIJE obavezna

diagram

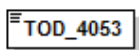

namespace <https://3s.panteon.biz/shemes/orders>

type **xs:string**

properties content simple

used by complexType [ORDERHeaderType](#)

source `<xs:element name="TOD_4053" type="xs:string"/>`

UNB_0004

(GLN Pošiljaoca dokumenta-ORDERS) vrednost JE obavezna

diagram

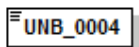

namespace <https://3s.panteon.biz/shemes/orders>

type **xs:string**

properties content simple

used by complexTypes [ContactType](#) [ItemType](#) [ORDERHeaderType](#)

source `<xs:element name="UNB_0004" type="xs:string"/>`

UNB_0010

(GLN dobavljača) vrednost JE obavezna

diagram

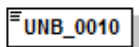

namespace <https://3s.panteon.biz/shemes/orders>

type **xs:string**

properties content simple

used by complexType [ORDERHeaderType](#)

source `<xs:element name="UNB_0010" type="xs:string"/>`

UNB_0017

(Datum prenosa - format YYYY-MM-DD) vrednost JE obavezna

diagram

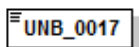

namespace <https://3s.panteon.biz/shemes/orders>

type **xs:string**

properties content simple

used by complexType [ORDERHeaderType](#)

source `<xs:element name="UNB_0017" type="xs:string"/>`

UNB_0019

(Vreme prenosa - format HH:MI) vrednost JE obavezna

diagram

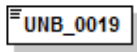

namespace <https://3s.panteon.biz/shemes/orders>

type **xs:string**

properties content simple

used by complexType [ORDERHeaderType](#)

source `<xs:element name="UNB_0019" type="xs:string"/>`

UNB_0020

(Broj razmene) vrednost JE obavezna

diagram

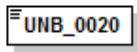

namespace <https://3s.panteon.biz/shemes/orders>

type **xs:string**

properties content simple

used by complexType [ORDERHeaderType](#)

source `<xs:element name="UNB_0020" type="xs:string"/>`